

TAGRAS OILFIELD  
SERVICES HOLDING



# CATALOG OF PRODUCTS AND SERVICES

Technology Management Service



We assist our Customer in improving the business performance by offering high-level service, products, and technology.

We value each employee and assist them in growing together with the company!

## Dear partner!

You are holding in your hands an updated catalog of products and services developed by experts of TMC Group to improve your business performance.

With 18-year experience in the successful implementation of projects for the oil-and-gas and machine-building branches of industry, we are ready to mobilize all the technical, intellectual, and creative potential of our company to solve the most complex problems.

We are trusted by major oil-and-gas industry leaders in the Russian Federation and the countries of the near abroad. The quality and innovation of TMC Group activities in the oilfield service market are recognized by high-class Russian and regional contests, among which are "100 Best Goods of Russia" and "Best Products and Services of the Republic of Tatarstan."

In our daily routine we are guided by our mission, as well as by our company's established and time-proven system of values, the main ones of which are:

- labor safety;
- continuous improvement and development of in-house business processes;
- lean manufacturing;
- technological effectiveness and efficiency;
- customer focus and ongoing commitment to new horizons.

Working with you, we are aware of the high responsibility, know-how and are always focused on results, which are formed on the basis of key performance indicators coordinated with you.

We wish you a smooth studying of the products and services of our company and are always ready to answer the questions you are interested in and provide prompt feedback.

**Anvar Gabdulmazitovich Yarullin**  
Director of TMC Group Managing Company LLC





## TNG-GROUP



geophysical exploration and seismic surveying



production, rental, and repair of oil-downhole equipment



passenger and freight transportation and logistics, special-purpose transportation services



construction and repair work in the power-generating complex and industrial construction

engineering and servicing of oilfield and drilling equipment



downhole treatment on construction and repair of FHF and EOR

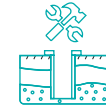

road construction and maintenance



comprehensive IT service, 1C adaptation and support, multifunctional service center



## TMC-GROUP

## TAGRAS-RS

## TATNEFTDOR

## TAGRAS-BUSINESSERVICE

## TAGRAS-TRANSERVICE

## TAGRAS-ENERGOSERVICE



## A DIVERSIFIED HOLDING COMPANY,

technological leader in the oil-and-gas service market of the Russian Federation, uniting companies with more than half a century of history

## WE ARE PROUD OF OUR EXPERTISE

and competencies of our specialists, our in-house upgraded production facilities, innovative equipment, and digital products

## WE ARE SYSTEMATICALLY REINFORCING

production capacity, increasing the use of advanced high-tech equipment, digital solutions, and innovative technologies



# TaGRAS

oilfield services  
company

## AREAS OF ACTIVITY:

- **Search and geologic exploration of oil fields** using up-to-date methods of onshore and offshore seismic surveying; oilfield geophysics and geoinformation systems; interpretation of data obtained from seismic surveying and oilfield geophysical works; development and manufacturing of innovative geophysical instruments and equipment
- **Drilling of directional and horizontal wells** for oil and gas of various complexity categories. Technological operations for sidetracking as well as horizontal sidetracking
- **Production of pipes and shaped products** in corrosion-resistant and heat-insulated versions for oil-and-gas pipelines, product pipelines, and heat supply systems (external, internal corrosion-resistant coating of pipes and shaped products)
- **Formation hydraulic fracturing**
- **A wide range of high-tech integrated services** in well construction: drill-bit services, mud-and-grouting service, geosteering support of wellbore drilling, drilling supervising, and drilling problems elimination using expandable casing
- **Repair, maintenance and rental of oil production equipment** (aboveground and downhole), manufacture and repair of drilling and workover equipment
- **Production of rocker-machines** of various capacities
- **Maintenance of electric submersible pumping units**, formation pressure maintenance system equipment, and production of submersible cable for electric submersible pumping units
- **Overhaul and repair of wells**
- **Production of equipment for well construction:** PDC-type drill bits, expandable casing, and sidetracking equipment
- **Power and heat supply of oil production facilities**, servicing of electric power facilities
- **Development of oil and gas fields**, construction of main oil and product pipelines, and construction of field infrastructure facilities
- **Provision of services** of special-purpose utility vehicles
- **Provision of cargo and passenger transportation**, including by tilt-covered transport, throughout Russia. Rotational transportation, including all-terrain vehicles
- **Construction, reconstruction, repair, and maintenance of roads**, provision of field facilities with access roads, and site development
- **Comprehensive accounting outsourcing**
- Personnel payroll **outsourcing**
- **HR records keeping and management**
- **IT infrastructure** maintenance
- **Maintenance** of 1C software products
- **Building and maintaining a comprehensive information security system** for an enterprise or group of companies
- **Industrial automation**
- **Customer support** in business trips in Russia and around the world

## OUR MISSION

At the nexus of technology and experience, we find effective solutions in providing a comprehensive range of services for the oil-and-gas and other economy sectors

## OUR VALUES

- Team
- Responsibility
- Safety
- Innovativeness
- Effectiveness

## OUR PRINCIPLES

- We ourselves do not break the law or the rules, and we prevent violations of others
- We study customer needs and offer better solutions
- We take care of the resources of the company, the country, and the planet
- We welcome new ideas and initiative
- We are result-oriented

+7 800 234-66-22  
callcenter@tagras.ru  
www.tagras.ru



## OILFIELD AND DOWNHOLE PUMPING EQUIPMENT

11	WELLHEAD FITTINGS	23	WELLHEAD FITTINGS WITH THERMAL COMPENSATION ANK-65×14-250-TK
12	Xmas Tree Assembly AFK1(Sh)-65(80,100)×21(14,35)K1(K2)	24	THERMAL RESISTANT WELLHEAD FITTINGS 2AF-80/50×40
14	INJECTION TREE ANK1(SH)-65(80,100)×21(14,35)K1(K2)	25	GATE VALVES OF THE TYPE ZD 65(80,100)×21(35) AND ZDSH 65(80)×21(35)
16	SMALL-SIZED INJECTION TREE ANK(Sh)-65×21(14) K1(K2) M1	26	DUAL-BORE WELLHEAD FITTINGS AUD 80/50-40
17	INJECTION TREE 2ANKSH-65×21(14,35) K1(K2) M2	27	SINGLE-BORE DOUBLE-ROW FITTINGS AOD 80/50-40
18	FITTINGS FOR INSTALLATION OF A SUCKER-ROD PUMP AU 140×50	28	PLUG-TYPE VALVE
19	FITTINGS FOR INSTALLATION OF AN ELECTRIC PUMP AUE 140×50	28	ANGLE VALVE VU 140×50
20	THERMAL-RESISTANT STEAM WELLHEAD FITTINGS ATPK-65×18-350 K1	29	CASING HEAD OF TYPE OK01-21-146 (168/178)×245 AND OK01-21-102 (114, 146, 168, 178)×168(178, 219, 245)
21	HEAT-RESISTANT STEAM INJECTION TREE ATPN-65×16-300K1	30	Slip Casing Head
22	HEAT-RESISTANT STEAM WELLHEAD INJECTION TREE ATPK 65-16-350 UHL1	31	CABLE TRANSIT AFK-2×21.F
		32	CABLE TRANSIT AFK-1×21.F
		33	CASING-HEAD STUFFING BOX SUS2A-73-31

34	MANUFACTURE AND REPAIR OF ROCKER-MACHINES
36	TMC POWER MAN™ PNEUMOHYDRAULIC DRIVE OF THE DOWNHOLE SUCKER-ROD PUMP WITH 30 TO 140 KN LOAD ON THE WELLHEAD ROD
38	PACKER ASSEMBLY M1-X
39	ENGINEERING AND CONSTRUCTION OF THE PROCESS TRAIN FOR DIAGNOSTICS AND REPAIR OF TUBING "TMC-HIGHTECH"
43	REPAIR OF TUBING
44	ENGINEERING AND CONSTRUCTION OF THE PROCESS TRAIN FOR DIAGNOSTICS AND REPAIR OF SUCKER RODS "TMC-SR LINE"
47	DOWNHOLE FILTER
48	SLOTTED DOWNHOLE FILTERS SLIDE™ (SDF)
49	PRODUCTION OF TUBING AS PER GOST 633-80, GOST 31446-2017
50	HKF-G TUBING WITH PREMIUM THREAD

52	HKF-THREADED TUBING
54	TUBING COUPLINGS
55	TUBING SUB
56	METAL STRUCTURES AND NON-STANDARD EQUIPMENT
57	MOVABLE RACK

## DRILLING EQUIPMENT

60	HIGH-STRENGTH HIGH-TORQUE CASING PIPE TMC-OTV-6,35
62	CASING PIPE TMC1-SRV HIGH-TORQUE HIGH-HERMETIC
64	CASING PIPE TMC1-SRV2 HIGH-TORQUE HIGH-HERMETIC
66	HEAVY DUTY CASING PIPE WITH BUTTRESS PROFILE
68	EXTREME-LINE CASING PIPE N-S.*BM FLUSH-JOINT HIGH-HERMETIC
70	CASING COUPLINGS
72	DRILL PIPE REPAIR

- 74 | DRILL PIPE SUBS
- 75 | Flash weld tool joints
- 76 | TYPES OF REPAIRABLE THREADED JOINTS
- 77 | LOCKING RING
- 78 | STRING SHOE WITH BKPOK CHECK VALVE AS PER
- 79 | STRING SHOE OF BK-P AND BKM TYPE
- 80 | STRING SHOE WITH BKO CHECK VALVE
- 81 | REPAIR OF HYDRAULIC AND PNEUMATIC TONGS
- 82 | DRILLING EQUIPMENT REPAIR
- 84 | REPAIR, MAINTENANCE AND TESTING OF BLOWOUT PREVENTION EQUIPMENT

## PIPELINE PRODUCTS

- 87 | METAL-PLASTIC PIPES AND PUP-JOINTS
- 88 | METAL-SPRAYED COATING OF END SECTIONS OF PIPES AND PIPELINE PARTS WITH AN INTERNAL CORROSION-RESISTANT COATING (MPK) PROTECTIVE SLEEVE MADE OF CORROSION-RESISTANT STEEL (FLUSH-JOINT), INSTALLED IN THE FACTORY IN THE AREA OF UNINSULATED PIPE / PART SECTION
- 89 | STEEL PIPES Ø 2.24-32.28 IN. WITH OUTER TWO- AND THREE-LAYER POLYETHYLENE COATING
- 90 | INTERNAL AND EXTERNAL CORROSION-RESISTANT COATING OF PIPELINE PARTS AND ASSEMBLIES
- 92 | PIPES, HEAT-INSULATED WITH POLYURETHANE FOAM FOR UNDERGROUND AND ABOVE-GROUND ROUTING
- 93 | TYPES OF HEAT-INSULATED PIPES
- 94 | SHAPED PARTS OF PIPELINES WITH HEAT-INSULATION OF POLYURETHANE FOAM
- 95 | TUBING, CASING, AND LINE PIPES OF STEEL WITH INTERNAL CORROSION-RESISTANT COATING
- 96 | SLEEVE TPS-TK  
Spec.
- 98 | POLYETHYLENE PIPES FOR INDUSTRIAL APPLICATIONS FOR SERVICE AND DRINKING WATER SUPPLY FOR GAS PIPELINES

- 99 | EXTERNAL CORROSION-RESISTANT COATING OF STEEL PIPES BASED ON POWDER MATERIALS
- 100 | MEST™ MECHANICAL ELECTRICALLY INSULATING CONNECTION OF PIPELINES
- 102 | POLYETHYLENE FILM

## OTHER SERVICES

- 105 | SCRAP METAL TRADING
- 106 | RENDERING OF METROLOGICAL SERVICES



Winner of the "Productivity Leaders' Cup" named after A. K. Gastev. Acknowledged leader in the implementation and development of lean manufacturing



TMC Group Managing Company LLC confirmed the status of "LEADER OF QUALITY" in the Republic of Tatarstan



Status as an accredited center of collective use in Skolkovo Technopark



Awards at the Moscow International Exhibition of Inventions and innovative technologies "Archimedes"



Winner of the competition "Best Goods and Services of the Republic of Tatarstan"



Winner of the competition "100 Best Goods of Russia"



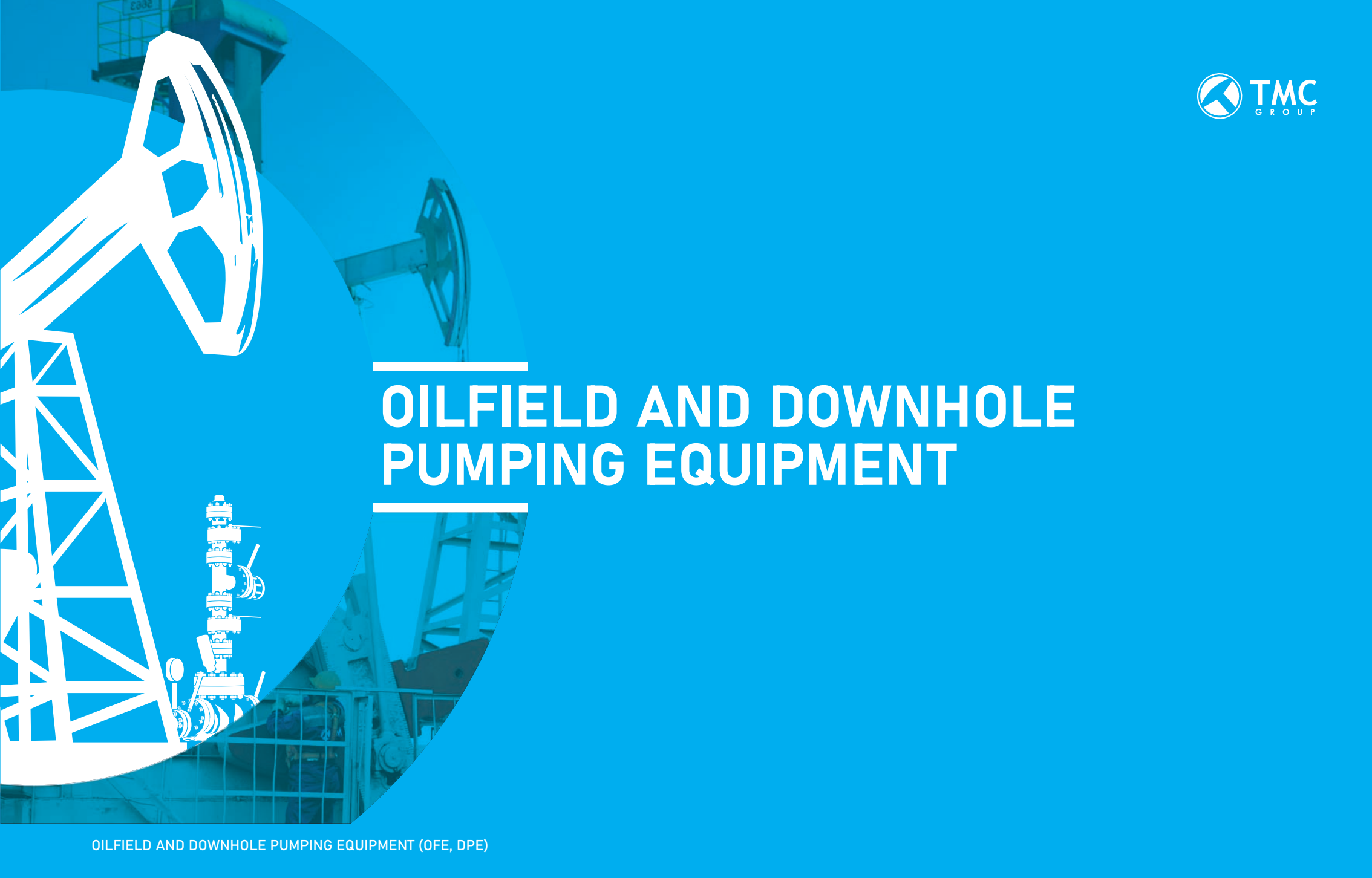

OILFIELD AND DOWNHOLE  
PUMPING EQUIPMENT

## OILFIELD AND DOWNHOLE PUMPING EQUIPMENT

11	WELLHEAD FITTINGS		
12	Xmas Tree Assembly AFK1(Sh)-65(80,100)×21(14,35)K1(K2)	22	HEAT-RESISTANT STEAM WELLHEAD INJECTION TREE ATPK 65-16-350 UHL1
14	INJECTION TREE ANK1(SH)-65(80,100)×21(14,35)K1(K2)	23	WELLHEAD FITTINGS WITH THERMAL COMPENSATION ANK- 65×14-250-TK
16	SMALL-SIZED INJECTION TREE ANK(Sh)-65×21(14) K1(K2) M1	24	THERMAL RESISTANT WELLHEAD FITTINGS 2AF-80/50×40
17	INJECTION TREE 2ANKSH-65×21(14,35) K1(K2) M2	25	GATE VALVES OF THE TYPE ZD 65(80,100)×21(35) AND ZDSH 65(80)×21(35)
18	FITTINGS FOR INSTALLATION OF A SUCKER-ROD PUMP AU 140×50	26	DUAL-BORE WELLHEAD FITTINGS AUD 80/50-40
19	FITTINGS FOR INSTALLATION OF AN ELECTRIC PUMP AUE 140×50	27	SINGLE-BORE DOUBLE-ROW FITTINGS AOD 80/50-40
20	THERMAL-RESISTANT STEAM WELLHEAD FITTINGS ATPK-65×18- 350 K1	28	PLUG-TYPE VALVE
21	HEAT-RESISTANT STEAM INJECTION TREE ATPN-65×16-300K1	28	ANGLE VALVE VU 140×50
		29	CASING HEAD OF TYPE OK01-21-146 (168/178)×245 AND OK01-21-102 (114, 146, 168, 178)×168(178, 219, 245)
		30	Slip Casing Head
		31	CABLE TRANSIT AFK-2×21.F
		32	CABLE TRANSIT AFK-1×21.F
		33	CASING-HEAD STUFFING BOX SUS2A-73-31
		34	MANUFACTURE AND REPAIR OF ROCKER-MACHINES
		36	TMC POWER MAN™ PNEUMOHYDRAULIC DRIVE OF THE DOWNHOLE SUCKER-ROD PUMP WITH 30 TO 140 KN LOAD ON THE WELLHEAD ROD
		38	PACKER ASSEMBLY M1-X
		39	ENGINEERING AND CONSTRUCTION OF THE PROCESS TRAIN FOR DIAGNOSTICS AND REPAIR OF TUBING "TMC-HIGHTECH"
		43	REPAIR OF TUBING
		44	ENGINEERING AND CONSTRUCTION OF THE PROCESS TRAIN FOR DIAGNOSTICS AND REPAIR OF SUCKER RODS "TMC-SR LINE"
		47	DOWNHOLE FILTER
		48	SLOTTED DOWNHOLE FILTERS SLIDE™ (SDF)
		49	PRODUCTION OF TUBING AS PER GOST 633-80, GOST 31446-2017
		50	HKF-G TUBING WITH PREMIUM THREAD
		52	HKF-THREADED TUBING
		54	TUBING COUPLINGS
		55	TUBING SUB
		56	METAL STRUCTURES AND NON- STANDARD EQUIPMENT
		57	MOVABLE RACK



## Purpose

**Wellhead fittings (AUD type)** are designed for wellhead setup and sealing, suspension of two downhole pipelines (tubing strings), individual control and management of downhole conditions of target formations, or fluid injection into formations.

**Wellhead fittings (AORZ type)** are designed for wellhead setup and sealing, as well as for simultaneous and separate water injection into two formations.

It is designed to use under outdoor conditions in a moderately cold climate zone as per GOST 16350-80 at ambient air temperature from -40 to +104 °F.

## Technical features

Feature name	AUD 40×14-146/48 (ESP)			AUD 50×14-168/60 (ESP)			AORZ 168-146×210
Operating pressure, psi	0.55	0.55	0.55	0.55	0.55	0.55	3.046
Nominal inside diameter, in.	1.58	1.58	1.58	1.97	1.97	1.97	1.58
Connecting thread	Casing thread 146 GOST 632-80 Tubing 48 hanger thread GOST 632-80			Casing thread 168 GOST 632-80 Tubing hanger thread 60 GOST 632-80			Casing thread 146 (168) GOST 632-80
Overall dimensions, in., NOV:							
length	45.47	45.47	44.69	45.47	45.47	44.69	78.74
width	23.43	23.43	11.81	23.43	23.43	11.81	70.87
height	84.45	1.733	82.09	75.79	83.86	73.62	78.74



Winner of the competition  
"100 Best Goods of Russia"



Contest diploma winner  
"100 Best Products of the  
Republic of Tatarstan".

# XMAS TREE ASSEMBLY AFK1(SH)-65(80,100)×21(14,35)K1(K2)

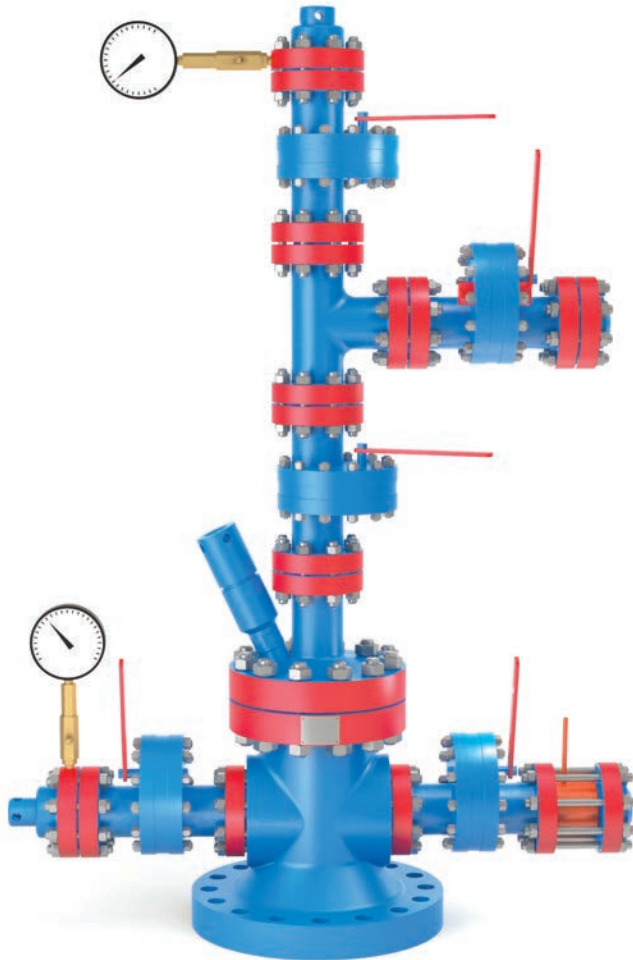

## Purpose

Xmas Tree Assemblies are designed for wellhead setup and sealing of flowing and injection wells, tubing string hangers, control and management of recovered medium withdrawal, performance of production operations, and repair and exploratory works. The fittings are equipped with ZD and ZDSh disc valves. Flow is regulated by changing the flow nipples on the ZDSh choke valve. The flow nipples are replaced without pressure release in the pipeline when the gate valve is closed for 5 minutes. Fittings do not have welded joints. The fittings can be converted to ANK injection type by removing the cable transit and installing a blanking plug. Wellhead fittings are equipped with shutoff valves in accordance with the customer's requirements.

## Technical features

Operating pressure, psi		2.031, 3.046, 5.076
Nominal inside diameter, in.	X-tree hole	2.56, 3.15, 3.94
	lateral outlets	1.97, 2.56, 3.15, 3.94
	string head lateral outlets	1.97, 2.56
Connecting thread	to tubing as per GOST 633-80	tubing 73, tubing 89
	to casing (for M2, M3) as per GOST 632-80	casing, 146, 168, 178 buttress thread 146, 168, 178
Resistance to downhole conditions as per GOST 13864-89		K1, K2
Operating medium temperature, °F, NOV		+248
Climatic version as per GOST 15150-69		UHL1 (HL1)
Ambient operating temperature limits, °F		-76... +104



## Types of flowcrosses

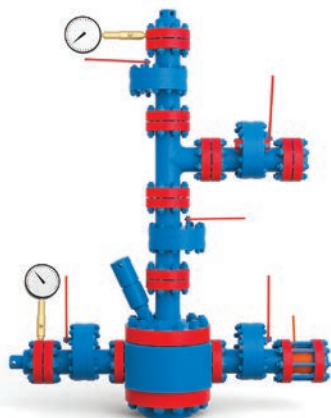

AFK1(Sh)-65x21K1

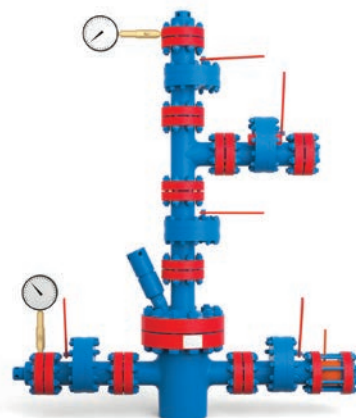

AFK1(Sh)-65x21K1M2

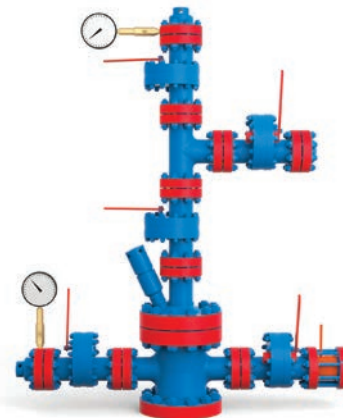

AFK1(Sh)-65x21K1M3

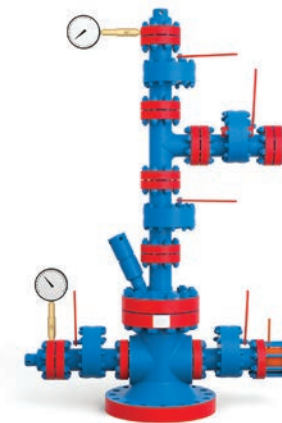

AFK1(Sh)-65x21K1M4

## Fitting configuration versions

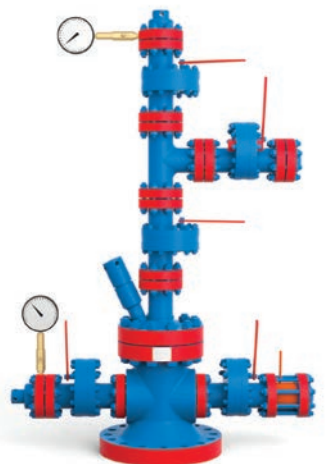

AFK1(Sh)-65x21K1(K2)M4  
Basic version

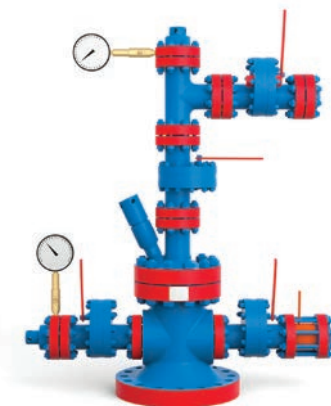

AFK1(Sh)-65x21K1(K2)M4-01  
Without lubricator valve

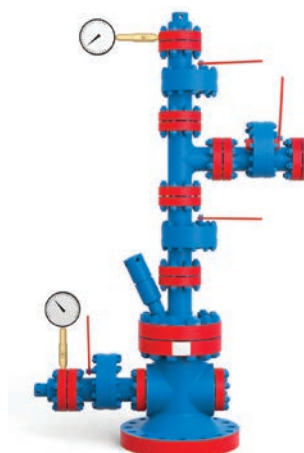

AFK1(Sh)-65x21K1(K2)M4-03  
Without gate valve on the flowcross lateral outlet

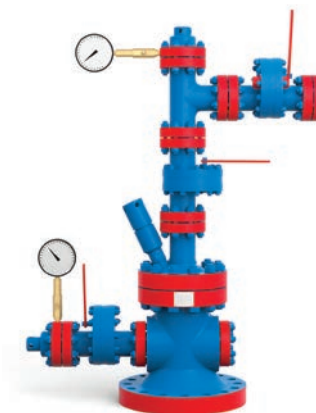

AFK1(Sh)-65x21K1(K2)M4-05  
Without lubricator valve and gate  
on the flowcross lateral outlet

# INJECTION TREE ANK1(SH)-65(80,100)×21(14,35)K1(K2)

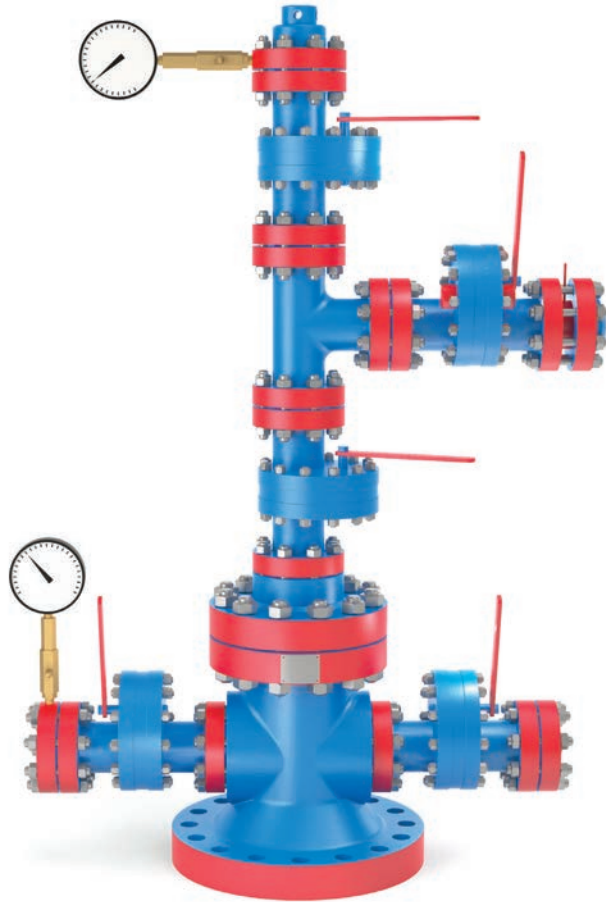

## Purpose

Injection trees are designed for wellhead setup and sealing of injection wells, tubing string hangers, control and management of the medium injected into the well, performance of production operations, and repair and exploratory works. The fittings are equipped with ZD and ZDSh disc valves. Flow is regulated by changing the flow nipples on the ZDSh choke valve. The choke valves are replaced without pressure relieving in the pipeline and with the gate valve closed for 5 minutes. Fittings do not have welded joints. Wellhead fittings are completed with shutoff valves according to the customer's requirements.

## Technical features

Operating pressure, psi		2.031, 3.046, 5.076
Nominal inside diameter, in.	X-tree hole	2.56, 3.15, 3.94
	lateral outlets	1.97, 2.56, 3.15, 3.94
	string head lateral outlets	1.97, 2.56
Connecting thread	to tubing as per GOST 633-80	tubing 73, tubing 89
	to casing pipes (for M2, M3) GOST 632-80	casing, 146, 168, 178 buttress thread 146, 168, 178
Resistance to downhole conditions as per GOST 13864-89		K1, K2
Operating medium temperature, °F, NOV		+248
Climatic version as per GOST 15150-69		UHL1 (HL1)
Ambient operating temperature limits, °F		-76... +104

## Types of flowcrosses

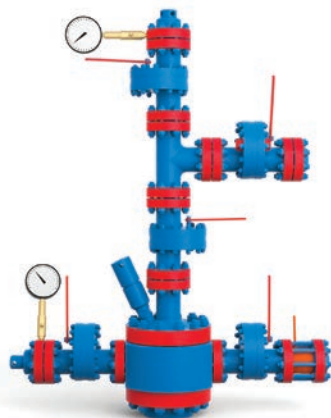

AFK1(Sh)-65x21K1

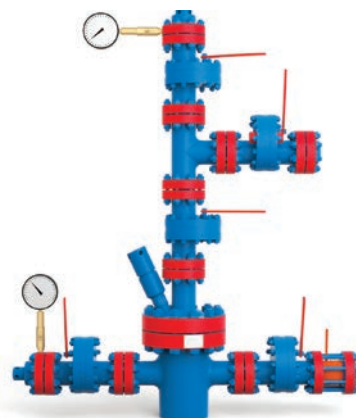

AFK1(Sh)-65x21K1M2

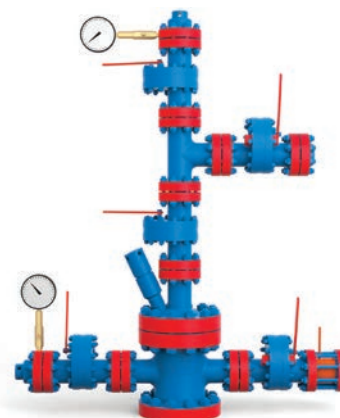

AFK1(Sh)-65x21K1M3

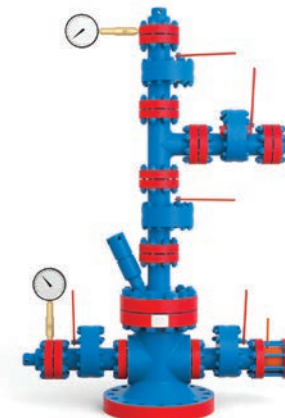

AFK1(Sh)-65x21K1M4

## Fitting configuration versions

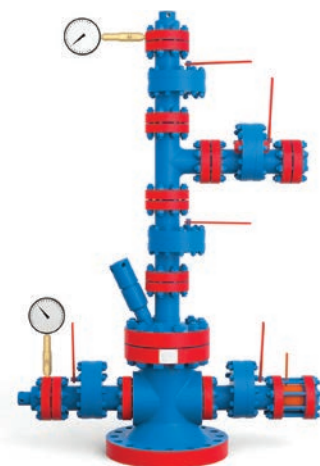

AFK1(Sh)-65x21K1(K2)M4  
Basic version

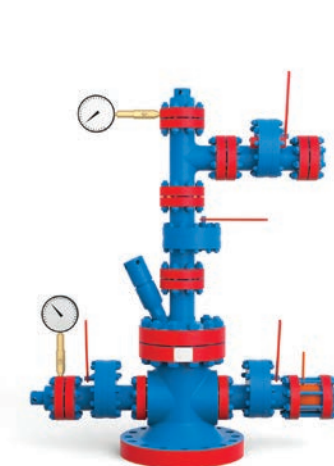

AFK1(Sh)-65x21K1(K2)M4-01  
Without lubricator valve

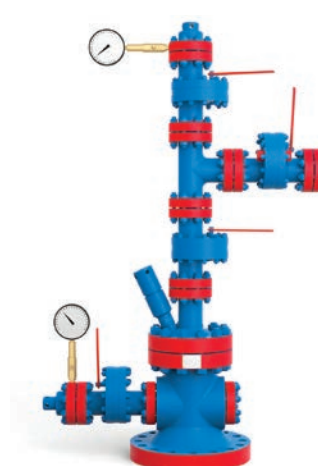

AFK1(Sh)-65x21K1(K2)M4-03  
Without gate valve on the flowcross  
lateral outlet

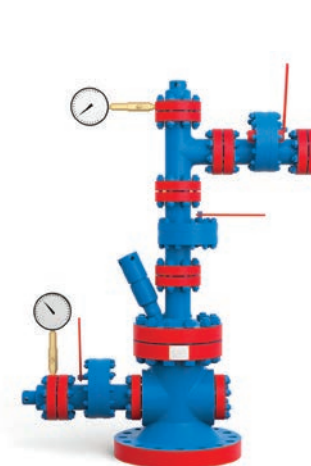

AFK1(Sh)-65x21K1(K2)M4-05  
Without lubricator gate and gate valve on  
the flowcross lateral outlet

# SMALL-SIZED INJECTION TREE ANK(SH)-65×21(14) K1(K2) M1

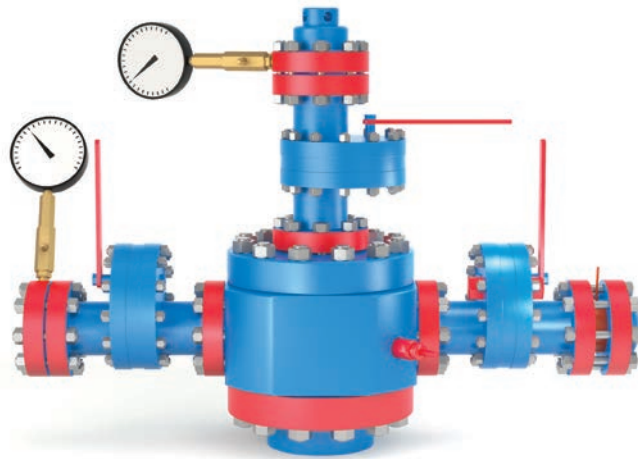

## Purpose

Injection trees are designed for wellhead setup and sealing of injection wells, tubing string hangers, control and management of the medium injected into the well, performance of production operations, repair and exploratory works. The fittings are equipped with ZD and ZDSh disc valves. Flow is regulated by changing the flow nipples on the ZDSh choke valve. The choke valves are replaced without pressure relieving in the pipeline and with the gate valve closed for 5 minutes. The weight and dimensions of the fittings are more than half of those of the classic design. Fittings do not have welded joints. Wellhead fittings are completed with shutoff valves according to the customer's requirements.

## Technical features

Operating pressure, psi		2.031, 3.046
Nominal inside diameter, in.	X-tree hole	2.56
	lateral outlets	2.56
Connecting thread	to tubing as per GOST 633-80	tubing 48, tubing 60, tubing 73
	to casing pipes GOST 632-80	casing, 146, 168, 178
buttress thread 146, 168, 178		K1, K2
Resistance to downhole conditions as per GOST 13864-89		K1, K2
Operating medium temperature, °F, NOV		+248
Climatic version as per GOST 15150-69		UHL1 (HL1)
Ambient operating temperature limits, °F		from -76... +104



# INJECTION TREE 2ANKSH-65×21(14,35) K1(K2) M2

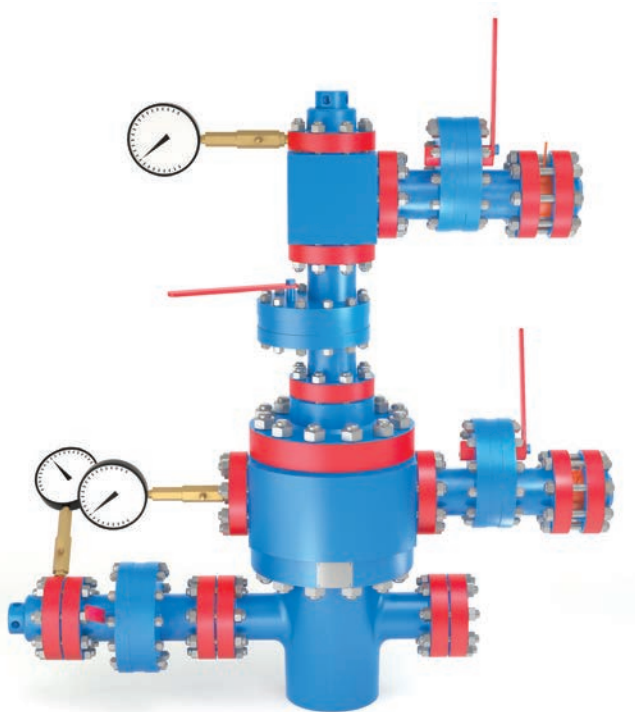

## Purpose

Injection trees are designed for wellhead setup and sealing of injection wells, tubing string hangers, control and management of the medium injected into the well, performance of production operations, repair and exploratory works. The fittings are equipped with ZD and ZDSh disc valves. Flow is regulated by changing the flow nipples on the ZDSh choke valve. The choke valves are replaced without pressure relieving in the pipeline and with the gate valve closed for 5 minutes. Fittings do not have welded joints. Wellhead fittings are completed with shutoff valves according to the customer's requirements.

## Technical features

	Operating pressure, psi	2.031, 3.046, 5.076
Nominal inside diameter, in.	X-tree hole	1.57, 2.56, 3.15
	lateral outlets	1.97, 2.56, 3.15
	string head lateral outlets	1.97, 2.56
Connecting thread	to tubing as per GOST 633-80	tubing 48, tubing 60, tubing 73, tubing 89
	to casing pipes GOST 632-80	casing, 146, 168, 178
	buttress thread 146, 168, 178	K1, K2
	Resistance to downhole conditions as per GOST 13864-89	K1, K2
	Operating medium temperature, °F, NOV	+248
	Climatic version as per GOST 15150-69	UHL1 (HL1)
	Ambient operating temperature limits, °F	-76... +104



## Purpose

The fittings are designed for wellhead setup and sealing equipped with a sucker-rod pump. The fittings for performing production operations, and repair and exploratory works.

The fittings are equipped with casing-head stuffing boxes with a spherical swivel joint allowing to compensate angular misalignments from the mismatch of wellhead and rocker-machine axes.

The fittings are equipped with an angle valve with a check valve, which allows discharging excessive pressure of gases from the annular space into the channel with the recovered medium.

By agreement with the customer, it is possible to change the fitting configuration.

## Technical features

Working pressure with rocking machine running, psi	580.2	
Operating pressure when the rocker-machine is not running, psi	2.031	
Nominal inside diameter, in.		
	1.97	
Connecting thread	to tubing as per GOST 633-80 tubing 73	
	to casing pipes casing, but-tress thread GOST 632-80	
Overall dimensions, in.	length	47.64
	width	2.116
	height	49.61
Resistance to downhole conditions as per GOST 13864-89		
	K1	
Operating medium temperature, °F, NOV	+212	
Ambient operating temperature limits °F	-40...+104	
Weight, lb	352.74	



Winner of the competition  
"100 Best Goods of Russia"



Contest diploma winner  
"100 Best Products of the  
Republic of Tatarstan"

# FITTINGS FOR INSTALLATION OF AN ELECTRIC PUMP AUE 140×50



## Purpose

The fittings are designed for wellhead setup and sealing equipped with an electric centrifugal pump. The fittings allow for performing production operations and repair and exploratory works. The fittings are equipped with an angle valve with a check valve, which allows discharging excessive pressure of gases from the annular space into the channel with the recovered medium. By agreement with the customer, it is possible to change the fitting configuration.

## Technical features

Operating pressure, psi		2,031
Nominal inside diameter, in.		1.97
Connecting thread	to tubing as per GOST 633-80	tubing 73
	to casing pipes casing, but-tress thread GOST 632-80	146, 168
Overall dimensions, in.	length	47,64
	width	2.116
	height	53.54
Resistance to downhole conditions as per GOST 13864-89		K1
Operating medium temperature, °F, NOV		+212
Ambient operating temperature limits, °F		-40...+104
Weight, lb		485



Winner of the competition  
"100 Best Goods of Russia"



Contest diploma winner  
"100 Best Products of the  
Republic of Tatarstan"

## Purpose and field of application

Fittings are designed for wellhead setup and sealing with cyclic mode of operation: steam injection and oil production using rod downhole sucker-rod pumps.

## Technical features

Operating pressure, psi	2.611
Nominal inside diameter, in.	2.56
Connecting thread of the tubing string	114 (4.49)
Operating medium temperature, °F, NOV	0.014
Resistance to the downhole conditions	K1
Climatic version	UHL

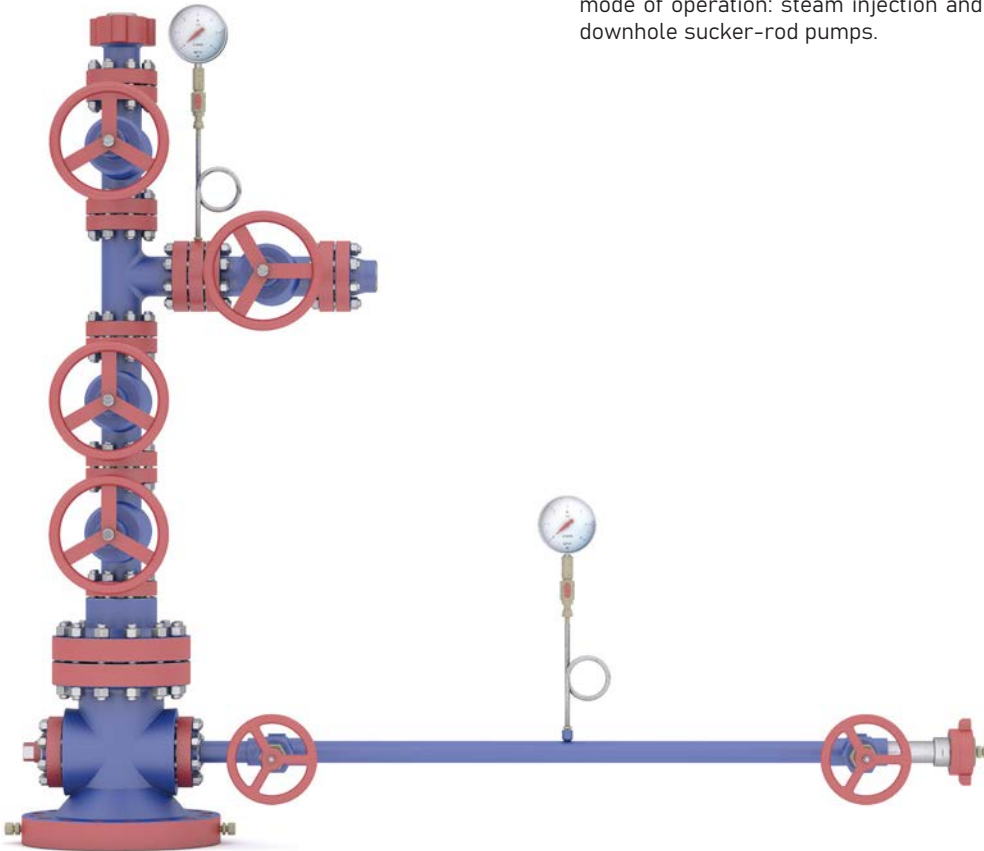

Fitting assembly variant for steam injection

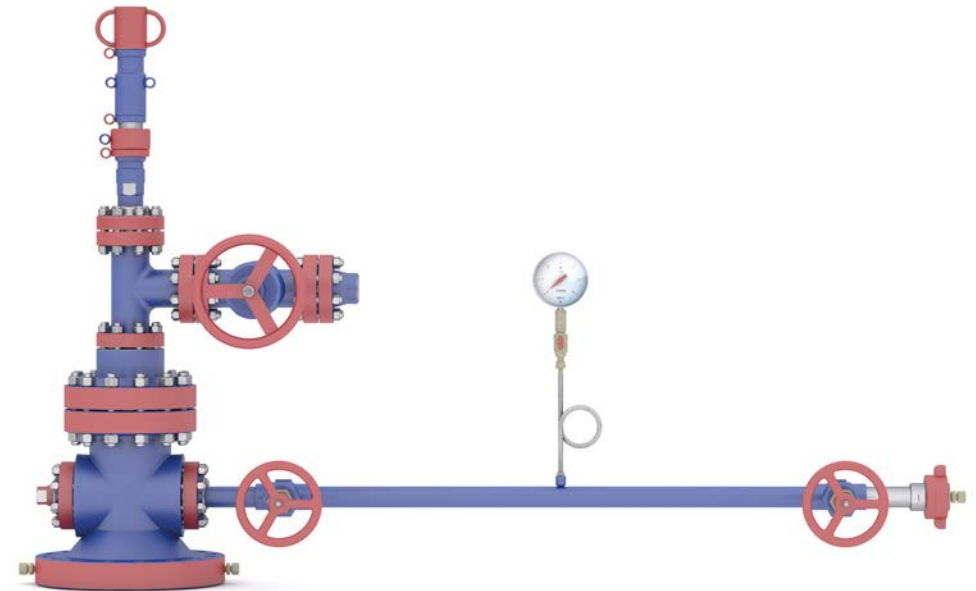

Fitting assembly variant for extraction with a sucker-rod pump



# HEAT-RESISTANT STEAM INJECTION TREE ATPN-65×16-300K1

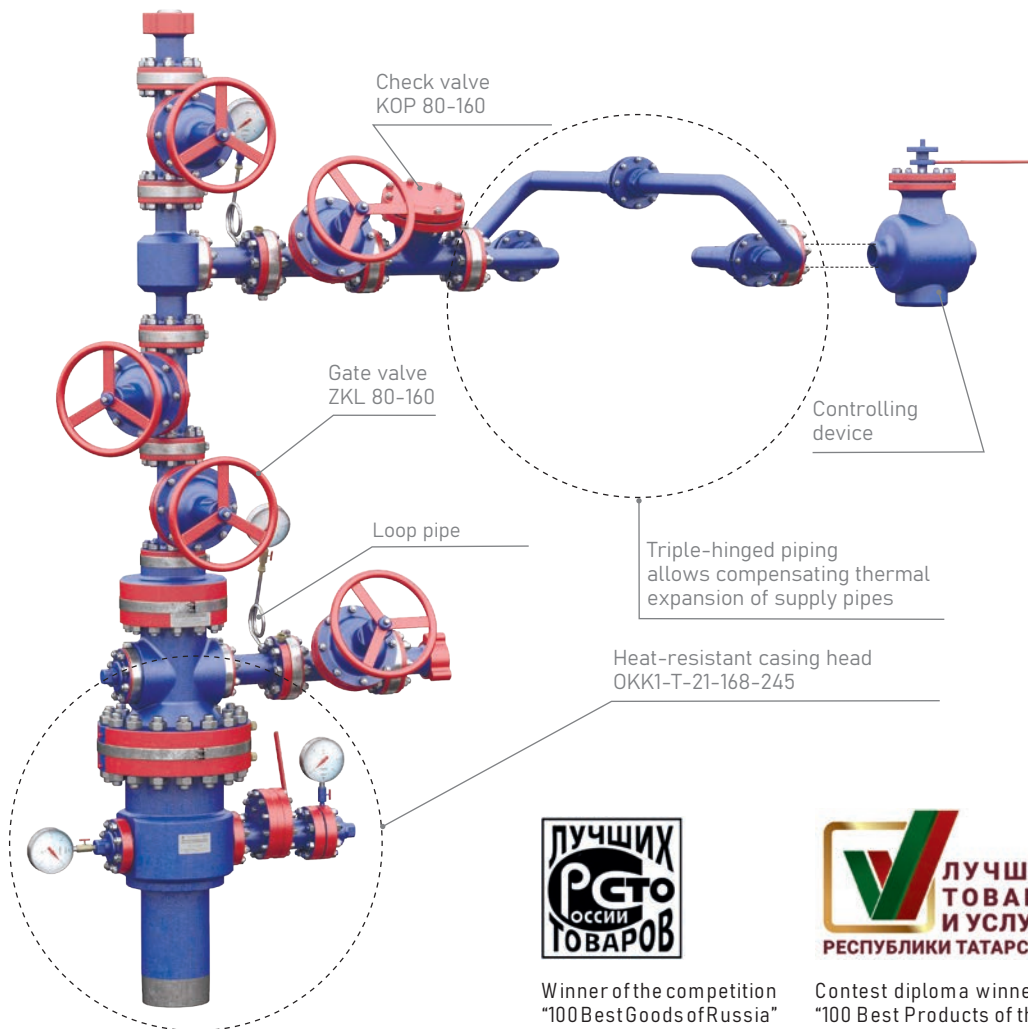

Winner of the competition "100 Best Goods of Russia"



Contest diploma winner "100 Best Products of the Republic of Tatarstan"

## Purpose

Wellhead fittings are designed for wellhead setup and sealing of steam injection wells in the production of super-viscous oil.

## Advantages

- Allows compensating the temperature expansions with triple-hinged piping.
- Simple, reliable locking and sealing devices.
- Repairability and accessibility of structural elements and components.
- Warranty – 18 months from the date of putting the wellhead fittings into operation.

## Technical features

Operating pressure, psi	2.321
Nominal inside diameter, in.	3.15/2.56
Connecting thread of the tubing string	89, 114
Casing diameters	6.61, 9.65
Operating medium temperature, °F, NOV	0.014
Resistance to the downhole conditions	K1
Climatic version	UHL

# HEAT-RESISTANT STEAM WELLHEAD INJECTION TREE

## ATPK 65-16-350 UHL1



### Purpose and field of application

Fittings are designed for wellhead setup and sealing of steam injection wells, string hangers, and control and management of the medium injected in super-viscous oil production.

### Advantages

- Temperature of injected steam up to 662 °F.
- The triple-hinged piping compensates for thermal expansions of the supply piping.
- The heat-resistant check valve of the in-house design eliminates the possibility of steam backflow.
- Ribbed sub excludes overheating of cable-transit stuffing-boxes.
- Installing the gauges on loop pipes eliminates overheating of the gauges.

### Technical features

Operating pressure, psi	2.321
Nominal inside diameter, in.	2.56
Operating medium temperature, °F	up to 662
Operating medium	steam, hot water, oil, gas
Corrosion-resistant design	K1
Climatic version	UHL 1
Connecting thread to the tubing string	73, 89
Connection thread to the casing string	127, 140, 146, 168, 178

# WELLHEAD FITTINGS WITH THERMAL COMPENSATION ANK-65×14-250-TK

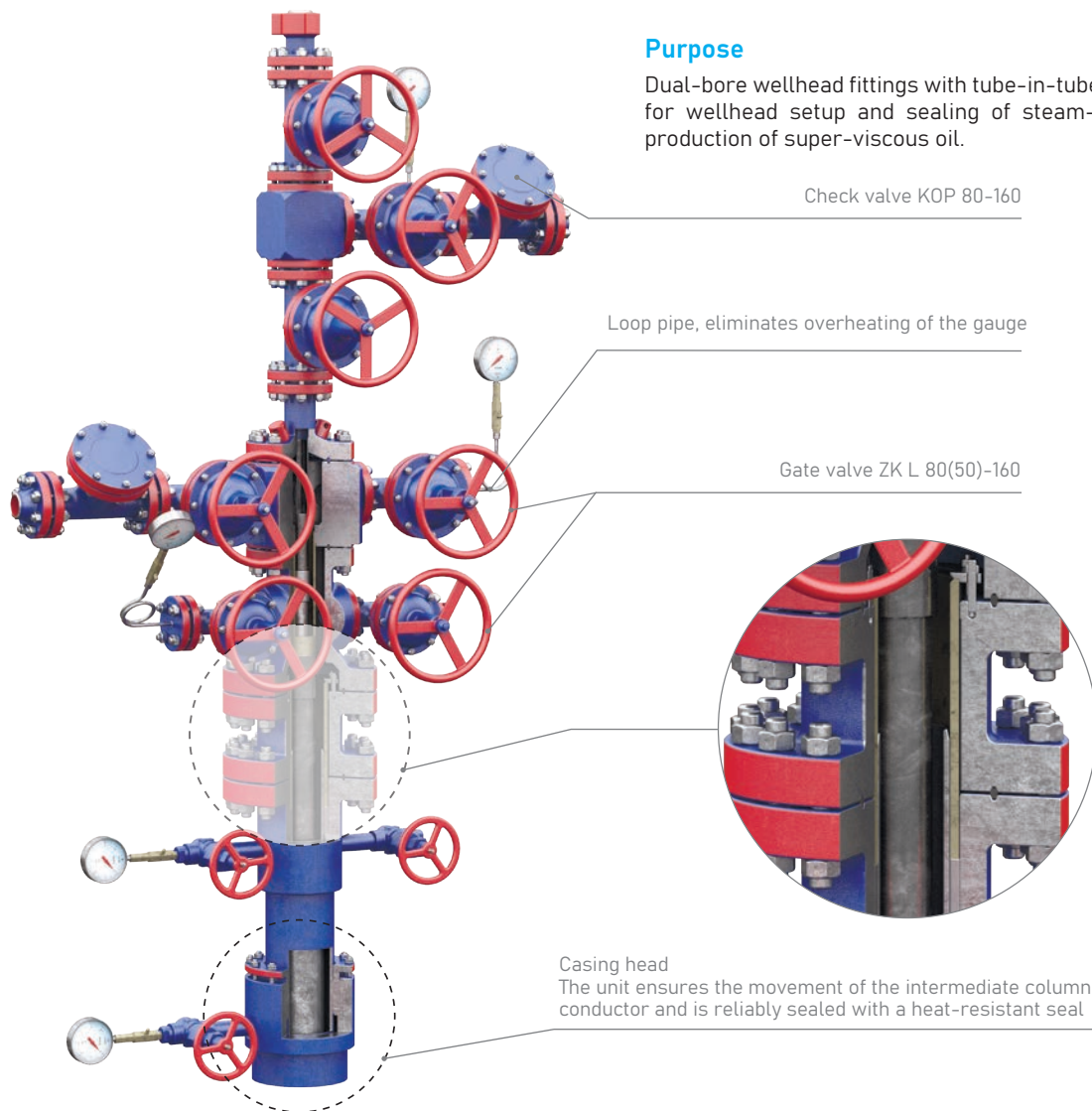

## Purpose

Dual-bore wellhead fittings with tube-in-tube hangers are designed for wellhead setup and sealing of steam-injection wells in the production of super-viscous oil.

Check valve KOP 80-160

Loop pipe, eliminates overheating of the gauge

Gate valve ZK L 80(50)-160

Casing head

The unit ensures the movement of the intermediate column inside the conductor and is reliably sealed with a heat-resistant seal

## Advantages

- Ability to compensate for thermal expansion of the conductor and intermediate column.
- Simple, reliable locking and sealing devices.
- Repairability and accessibility of structural elements and components.

## Technical features

Operating pressure, psi	0.55
Nominal inside diameter, in.	3.15/2.56/1.97
Connecting thread of the tubing string	60, 114
Casing string diameters, in.	7.01, 9.65, 12.76
Operating medium temperature, °F, NOV	482
Resistance to the downhole conditions	K1
Climatic version	UHL

Thermal compensation unit  
Compensates thermal expansions of the production string by up to 27.56 in.  
Advantages:  
highly hermetic;  
the coil is made of solid stock;  
complete with a specially machined pup-joint.



Winner of the competition  
"100 Best Goods of Russia"



Contest diploma winner  
"100 Best Products of the Republic of Tatarstan"

# THERMAL RESISTANT WELLHEAD FITTINGS 2AF-80/50×40

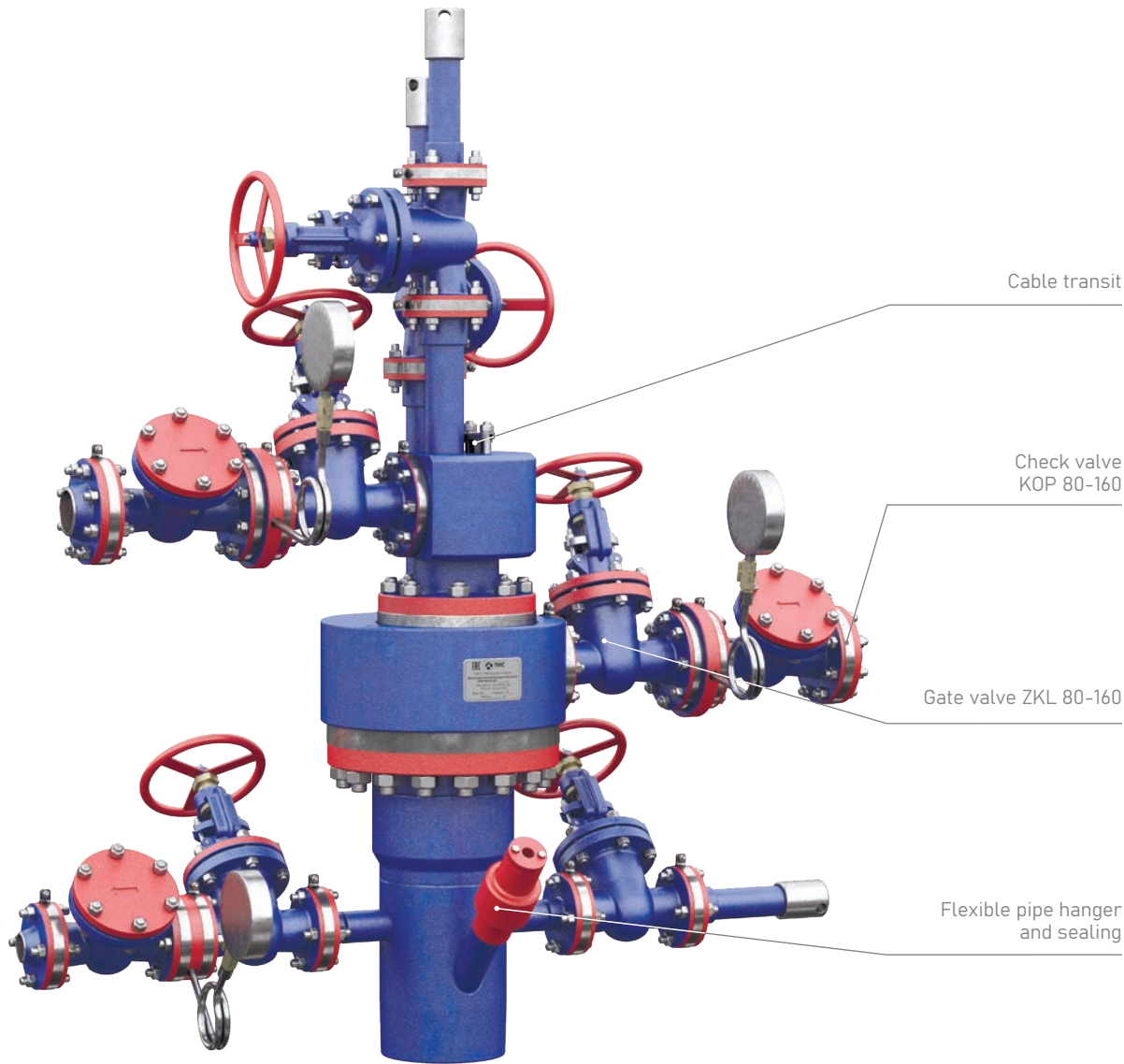

## Purpose

Dual-bore wellhead fittings with parallel tubing hangers are designed for wellhead setup and sealing of production and steam injection wells in the production of super-viscous oil.

## Advantages

- It is equipped with a sealed entry and a hanger for a flexible pipe of the well telemetry system.
- Simple, reliable locking and sealing devices.
- Repairability and accessibility of structural elements and components.

## Technical features

Operating pressure, psi	0.58
Nominal inside diameter, in.	3.15/1.97
Connecting thread of the tubing string	73, 89
Casing string diameters, in.	9.65
Operating medium temperature, °F, NOV	482
Resistance to the downhole conditions	K1
Climatic version	U



Winner of the competition  
"100 Best Goods of Russia"



Contest diploma winner  
"100 Best Products of the  
Republic of Tatarstan"

# GATE VALVES OF THE TYPE ZD 65(80,100)×21(35) AND ZDSh 65(80)×21(35)



## Purpose

ZD 65×21 steel gate valve with a disk slide (full-load) is designed for operation as a locking device on wellhead equipment and pipelines transporting liquid and gaseous media, oil, and service water. The steel gate valve with a disc slide, choke type ZDSh 65×21 (with quick-change choke), is designed to operate as a locking device and ensure stepwise

control of fluid flow in wellhead equipment and pipelines transporting liquid and gaseous media, oil, and service water with CO<sub>2</sub> and H<sub>2</sub>S volume content up to 6% and operating medium temperature not more than + 248 °F. ZDSh 65×21 gate valve chokes are replaced by one operator when the gate valve is closed without pressure release from pipelines for not more than 5 min.

## Technical features

Seq. No.	Feature name	Unit	Value
1	Operating pressure	psi	3.046, 5.076
2	Nominal inside diameter	in.	2.56, 3.15, 3.94
3	Nominal inside diameter of quick-change metal-ceramic throttling chokes (for gate valve ZDSh)	in.	0.08, 0.12, 0.16, 0.20, 0.24, 0.28, 0.31, 0.35, 0.39, 0.47
4	Operating medium		service water, oil, gas
5	Operating medium temperature	°F	no more than +248
6	Leakage class of the gate according to GOST R 54808-2011		A
7	Medium feed direction		any
8	Type of gate valve flange connections		GOST 28919-91
9	Resistance to downhole conditions as per GOST 13846-89		K1
10	Ambient operating temperature limits	°F	-76... +104
11	Reliability indicators, not less: total service life full average life mean time between failures average overhaul life	years cycle cycle years	15 1 800 600 5



Winner of the competition  
"100 Best Goods of Russia"



Contest diploma winner  
"100 Best Products of the  
Republic of Tatarstan"



# DUAL-BORE WELLHEAD FITTINGS AUD 80/50-40



## Purpose

Fittings are designed for wellhead setup and sealing, hanger of two parallel downhole pipelines (pipe strings) and flexible pipe with fiber-optic cable sealing, control and management of production, and (or) injection of the operating medium during realization of steam-cycling impact on the productive formation.

## Technical features

Parameters		AUD 80/50-40
Operating pressure, psi		0.58
Nominal inside diameter, in.		
main branches		3.15
process branches		1.97
Cable seal inside diameter, in.		0.51
Flexible pipe nominal diameter, in.		0.98, 1.50
Connecting thread	to casing pipes GOST 632-80	245, 324
	to borehole pipelines according to GOST 633-80	73, 89
	to the outer borehole pipeline according to GOST 632-80	-
Overall dimensions, in.	length	72.56
	width	56.61
	height	56.57
Number of suspended downhole pipelines, pcs.		2
Number of suspended flexible pipes, pcs.		1
Resistance to downhole conditions as per GOST 13864-89		K1
Operating medium		steam, water, oil, gas
Operating medium temperature, °F, NOV		482
Climatic version as per GOST 15150-69		UHL
Weight, lb, NOV		1.506



Winner of the competition  
"100 Best Goods of Russia"



Contest diploma winner  
"100 Best Products of the  
Republic of Tatarstan"



# SINGLE-BORE DOUBLE-ROW FITTINGS AOD 80/50-40

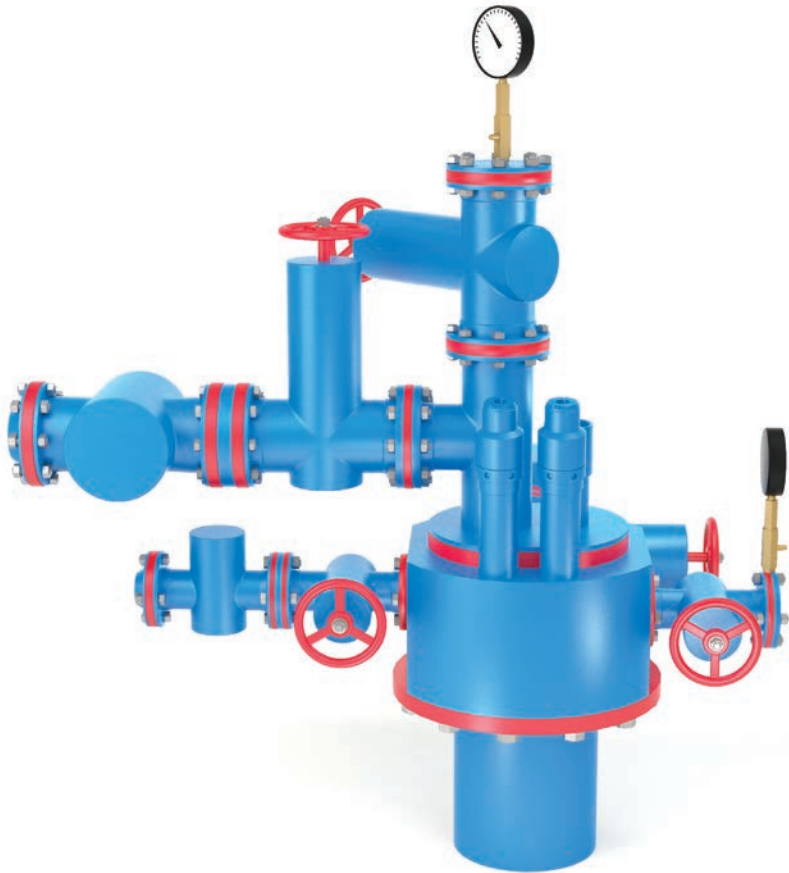

## Purpose

Fittings are designed for wellhead setup and sealing, hanging of two downhole pipelines (pipe strings), located in the well one inside the other, and individual control and management of production and (or) injection of the operating medium in the well.

## Technical features

Parameters		AOD 80/50-40
Operating pressure, psi		580.2
Nominal inside diameter, in.		
- main branches		3.15
- process branches		1.97
Cable seal inside diameter, in.		0.51
Flexible pipe nominal diameter, in.		0.98
Connecting thread	to casing pipes GOST 632-80	9.65
	to the inner borehole pipeline according to GOST 633-80	89 (3.50)
Overall dimensions, in.	length	66.54
	width	44.49
	height	78.15
Number of suspended downhole pipelines, pcs.		2
Number of suspended flexible pipes, pcs.		1
Resistance to downhole conditions as per GOST 13864-89		K1
Operating medium		steam, water, oil, gas
Operating medium temperature, °F, NOV		482
Climatic version as per GOST 15150-69		UHL
Weight, lb, NOV		1.592

## PLUG-TYPE VALVE



### Purpose

Plug-type valve is designed for closing ducts and piping arrangement.

### Technical features

Operating pressure, psi	3.046	
Nominal inside diameter, in.	1.97	
Operating medium	process water, cement mortar	
Connecting thread	tubing 60 GOST 633-80	
Overall dimensions, in.	length	7.87
	width	3.94
	height	9.05
Operating medium temperature, °F, NOV	+122	
Weight, lb	27.56	

## ANGLE VALVE VU 140×50



### Purpose

Angle valve is designed for closing the passages of oil and water pipelines.

### Technical features

Operating pressure, psi	0.55	
Nominal inside diameter, in.	1.97	
Operating medium	Service water, oil, petroleum products	
Connecting thread	tubing 60 GOST 633-80	
Leakage class of the shutter	A as per GOST 9544-93	
Overall dimensions, in.	length	14.57
	width	10.63
Operating medium temperature, °F, NOV	+212	
Weight, lb, NOV	33.07	

# CASING HEAD OF TYPE OK01-21-146 (168/178)×245 AND OK01-21-102 (114, 146, 168, 178)×168(178, 219, 245)



## Purpose

The casing head of TYPE OKO 21-146(168/178)×245 is designed for suspension of production string, piping of casing upper ends, sealing of inter-string space, and pressure control therein.

## Field of application

The installation of the casing head on the well allows to:

- drill for the production string through the casing-head case mounted on the conductor;
- install blowout preventers on the casing-head case through the crossover flange;
- unload the production string directly into the casing-head case;
- ensure mud circulation during grouting through ducts in the suspension sleeve;
- monitor the pressure in the inter-string space;
- install the Xmas Tree Assembly on the casing-head coupling.

## Advantages

- A wide range of schedule-sizes for casing string options.
- Small size and low cost.
- Reduces drilling costs due to ease of casing-head installation and blowout preventer.

## Casing head sizes

- OK01-21-146(168)×245
- OK01-21-114×178
- OK01-21-114×168
- OK01-21-146/114×178
- OK01-21-146×219
- OK01-21-178×245
- OK01-21-102×168

Ball valve, union-type gate valve, and gauge valve can be used as locking devices, or they can be closed with a plug with threaded tubing 60

## Technical features

Operating pressure, psi	3.046
Connecting thread to the production string as per GOST 632-80, in.	4.02, 4.49, 5.75, 6.61, 7.01
Connecting thread to the conductor as per GOST 632-80	168, 178, 245
Connecting thread of lateral outlets as per GOST 633-80	box tubing 60
Operating medium temperature, NOV, °F	248
Resistance to downhole conditions as per GOST 13846-89	K1
Operating medium	oil, natural gas, process water, drilling mud
Ambient operating temperature limits, °F	-76... +104



Contest diploma winner  
"100 Best Products  
of the Republic of  
Tatarstan"



## Purpose

- Production casing landing.
- Installation of well control equipment when drilling and cementing wells.
- Separation and sealing of tubing-casing annulus.
- Tubing-casing annulus pressure control.
- Christmas tree installation.

## Application

- oil and gas producing wells.

## Advantages

- Drilling for production casing is done through the casing head installed on the surface casing; well control equipment is installed on the casing head.
- Production casing is discharged into the casing head.
- Casing head design ensures fluid circulation when washing and cementing wells.

## Specifications

Hanger type	slip hanger
Surface casing diameter, in	9.65
Production casing diameter, in	5.75 (6.61, 7)
Lateral outlet nominal size, in	2.56
Operating pressure, psi	3045.8, 5076.3
Max operating environment temperature, °F	248
Corrosion resistance	K1, K2
Climatic version	C1 (suitable for operation in cold climate) XЛ1

## Manufacturer's Warranty

The manufacturer guarantees that slip casing heads conform to the specifications providing that the condition requirements for transportation, storage, installation, and operation are met.

The operating lifetime is at least 15 years from the date of setting into operation.

# CABLE TRANSIT AFK-2x21.F

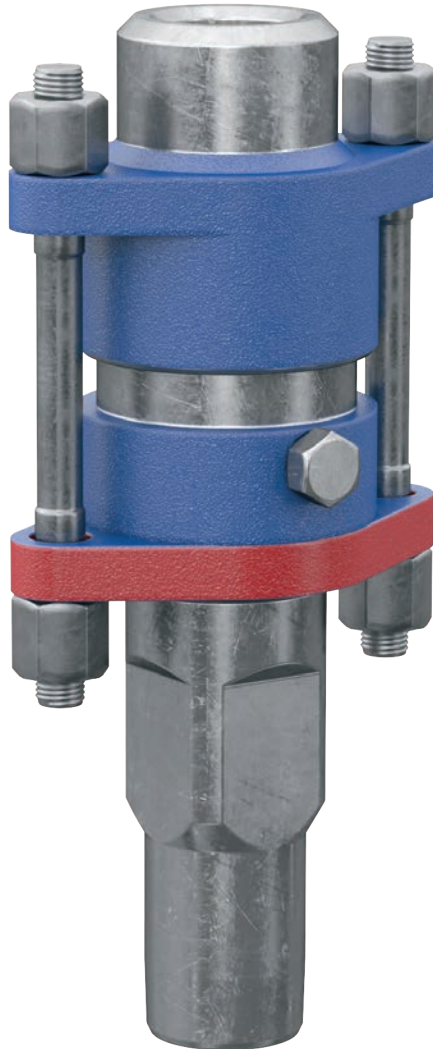

## Purpose

Cable transit AFK-2x21.F is a device intended for sealing ESP cable in wellhead casing heads of producing wells. The cable transit has a double stuffing-box seal. The cable transit design allows the stuffing-box crimping after installation thereof on the well.

## Technical features

Feature name	Value
Operating pressure, psi	3.046
Connecting thread	tubing 60 GOST 633-80
Type	double seal
Types of stuffing-boxes, in.	
Cable-transit stuffing-box (cable 3×0.39 in.2) SKV 53.64.47.210	0.12×0.32 in.
Cable-transit stuffing-box (cable 0.12×0.63 in.2) SKV 53.64.47.210	0.12×0.35 in.
Cable-transit stuffing-box (cable 0.12×0.98 in.2) SKV 53.64.47.210	0.12×0.39 in.
Cable gland (cable + capillary pipe 0.16×0.63 in. 2) SKV 53.64.47.210	0.16×0.35 in.
Downhole conditions as per GOST 13846-89	K1
Operating medium temperature, NOV, °F	248
Operating medium	oil, natural gas, process water
Ambient operating temperature limits, °F	-76... +104
Overall dimensions, in.:	
- length	7.09
- width	5.71
- height	14.69
Weight, lb	28.66

# CABLE TRANSIT AFK-1x21.F



## Purpose

Cable transit AFK-1x21.F is a device intended for sealing ESP cable in wellhead fittings of producing wells. The cable transit has a single stuffing-box seal.

## Technical features

Feature name	Value
Operating pressure, psi	3.046
Connecting thread	tubing 60 GOST 633-80
Type	double seal
Types of stuffing-boxes, in.	
Cable-transit stuffing-box (cable 3x0.39 in.2) SKV 53.64.47.210	0.12x0.32 in.
Cable-transit stuffing-box (cable 0.12x0.63 in.2) SKV 53.64.47.210	0.12x0.35 in.
Cable-transit stuffing-box (cable 0.12x0.98 in.2) SKV 53.64.47.210	0.12x0.39 in.
Cable gland (cable + capillary pipe 0.16x0.63 in. 2) SKV 53.64.47.210	0.16x0.35 in.
Downhole conditions as per GOST 13846-89	K1
Operating medium temperature, NOV, °F	248
Operating medium	oil, natural gas, process water
Ambient operating temperature limits, °F	-76... +104
Overall dimensions, in.:	
- Length	6.50
- width	3.94
- height	0.014
Weight, lb	14.55



# CASING-HEAD STUFFING BOX SUS2A-73-31

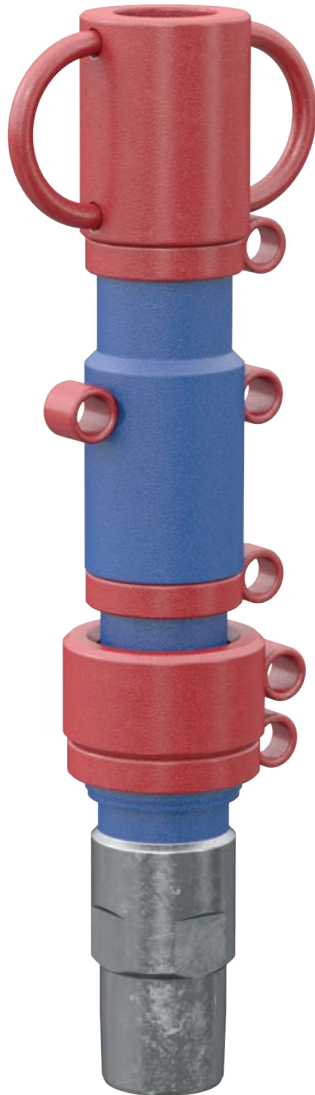

## Purpose

Wellhead stuffing box with a self-aligning head of SUS type is intended for sealing the stuffing-box rod of wells operated by sucker-rod pumps.

## Technical features

Feature name	Value
Operating pressure, psi	0.58
The highest pressure (with the wellhead rod stationary and the sleeves in the tightened state), psi	0.55
Connecting thread	tubing 73 GOST 633-80
Wellhead rod diameter, in.	1.22
Downhole conditions as per GOST 13846-89	non-corrosion-resistant and K1
Operating medium temperature, NOV, °F	248
Operating medium	oil, natural gas, process water
Ambient operating temperature limits, °F	-76... +104
Overall dimensions, in.:	
- length	22.68±0.20
- height	9.65
Weight, lb	57.32

# MANUFACTURE AND REPAIR OF ROCKER-MACHINES



## Purpose

The rocker-machine is designed to give a reciprocating motion to the plunger of a sucker-rod pump when pumping liquids from oil wells.

The downhole sucker-rod pump drives are produced of the following types:

TMC PNSh(T) 60-3-2800/80-3-40, TMC PNSh 60-2.1-2500/80-3-40,  
TMC SK 60-2.1-2500/8-3,5-4000, TMC SK 100-3,5-56,  
TMC SK T120-56

where:

TMC is a trademark of the manufacturer;

PNSh(T)—sucker-rod pump drive (pedestal-type);

SK—rocker-machine;

60/80/100/120—maximum load on the wellhead rod (kN, NOV);

6.89/9.84/11.48—maximum stroke length of the stuffing-box rod (ft);

1.844/2.065/4.130—output torque rating (lbf ft).

- Integrated maintenance of oilfield equipment.
- Lease with maintenance of oilfield equipment on mutually beneficial terms.

- Dimension inspection of metal structures.
- Restoration of damaged areas.
- Determination of the SK equilibrium by the instrument.
- Tightening of all fasteners and threaded connections.
- Inspection and repair of the balancer assembly.
- Inspection and repair of the rod rotator—a check of its operability.
- Lubrication of bearing assemblies and threaded connections. Packing of stuffing-box seals.
- Gearbox oil refilling/change.
- Replacement of worn and failed parts and assemblies.
- SK per-unit repair.
- SK overhaul.
- SK painting.
- Replacement of the V-belt transmission.
- Repair, manufacture, and installation of fencing devices.



Winner of the competition  
"100 Best Goods of  
Russia"

## Technical features

Parameter name	TMC PNSht 60-3-2800	TMC PNSht 80-3-40	TMC PNSh 60-2,1-2500	TMC PNSh 80-3-40	TMC SK 6-2,1-2500	TMC SK 8-3,5-4000			TMC SK 100	TMC SK T120	
Load on the wellhead rod, (lb)	132.28	3.15	132.28	176.37	132.28	176.37			220.46	264.56	
Wellhead rod stroke length, ft.	9.8; 8.2; 6.5; 5.2; 3.9	9.8; 8.2; 6.5; 5.2; 3.9	6.8; 5.9; 4.9; 3.9; 2.9	9.8; 8.2; 6.5; 5.2; 3.9	6.8; 5.9; 4.9; 3.9; 2.9	11.4; 9.8; 8.2; 6.8; 5.9			11.4; 9.8; 8.2; 6.8; 5.2; 3.9	9.8; 8.2; 6.8; 5.2; 3.9	
Wellhead rod oscillation frequency range per min. (stepwise control with interchangeable pulleys)	2.2-3.5	2.4-3.4	3-6	5-8	4-6	5-14	3.8-6	5.8-8.1	8.6-12	1.3-6; 5.8-8.1; 8.6-12	4.3-6; 5.8-8.1; 8.6-12
Output torque rating, (kN·ft)	20.652	29.502	18.439	29.502	18.439	29.502			41.303	41.303	
Drive overall dimensions (at the horizontal position of the balancer), in., NOV:											
-length	244.1	279.5	317.3	279.5	255.1	332.7			421.3	375.2	
-width	100.9	122.0	105.9	105.9	105.9	105.9			131.9	131.9	
-height	229.9	265.7	214.6	212.0	178.3	244.5			28.9	270.9	
Drive weight, lb, NOV	19.401	28.682	18.827	27.337	19.070	31.306			29.762	29.542	

# TMC POWER MAN™ PNEUMOHYDRAULIC DRIVE OF THE DOWNHOLE SUCKER-ROD PUMP WITH 30 TO 140 KN LOAD ON THE WELLHEAD ROD



## Purpose

The TMC POWER MAN™ pneumohydraulic drive is intended to provide the reciprocating motion of a downhole sucker-rod pump when pumping out fluids from oil wells..

## Field of application

- Well development after drilling and workover.
- Operational selection of optimal well operation parameters during the development period.
- Operation on wells equipped with single-lift equipment for the separate production (ESP).
- Watercut studies owing to the possibility of operational changes in parameters of operation of the downhole sucker-rod pump plunger when switching from one formation to another (within 5 minutes by one operator).
- Operation of intermittently operating well stock that has been rendered inactive. Possibility to operate the downhole sucker-rod pump in wide ranges; the minimum stroke length is 0.82 ft.
- Conducting reestablishment works on wells with the risk of rod string catching and jamming.

## Advantages over traditional drives

- Multiple times lower specific quantity of metal and weight compared to other downhole sucker-rod pump drives up to 70%.
- Reduction of assembling and dismantling and commissioning time by up to 60%.

- Remote control of the hydraulic drive and automatic maintenance of operating modes.
- Continuously variable number of swings and pump plunger stroke length without stopping the drive by one operator within 5 minutes.
- Delay of the pump plunger in the upper position (an increase of the pump fill rate).
- Availability of the “spudding” function (to take the well out of jamming).
- Reducing energy costs by up to 30%.
- The hydraulic drive is programmed for maximum well delivery and for optimization of specific power consumption and dynamic level.
- Reduced equipment wear and increased well’s inter-overhaul time.
- Operation of three wells with a single hydraulic drive (special version of the hydraulic drive).

## Support equipment (at customer’s option)

- Rod rotator (RR).
- Special shelter (booth) for the hydraulic power unit in explosion-proof and huffer-proof versions.
- Remote control function with the possibility of changing parameters, remote monitoring, and online control of hydraulic drive operation from the operator console.

## Technical features

Drive brand	TMC POWER MAN (single-lift)	TMC POWER MAN (double-lift)	TMC POWER MAN (reestablishment)	TMC POWER MAN (long stroke)
Maximum load on the wellhead rod, kN	30 to 140			
Wellhead rod stroke length, ft.	0.7 to 19.7			
Stroke length change pitch, ft.	stepless			
Number of 2 strokes per minute	0.3 to 4			
Electric motor power, kW	5.5-7.5-11 to 15-18-22			
Motor and pump overload protection	automatic			
Balancing system	pneumatic (balancing with compressed nitrogen)			
Control station	CS SKAD (adapted for operation with a hydraulic drive)			
Derrick weight with hydraulic cylinder (weight of complete set), lb.	1.543 (5.335±110.2) weight - 1 pc., hydraulic power unit - 1 pc.	1.543 (8.466±110.2) weight - 1 pc. hydraulic power unit - 2 pc.	1.543 (5.512±110.2) weight - 1 pc. hydraulic power unit - 1 pc.	1.653 (5.512±110.2) weight - 1 pc. hydraulic power unit - 1 pc.
Weight of complete set, lb	5.335±110.2 to 8.466±110.2			
Overall dimensions (length, width, height), ft				
- frame	2.3x4.6x13.1 to 2.3x4.6x42.7			
- hydraulic power unit	4.4x4.6x5.6			
Operating temperature, °F	-40... +104			
Rod rotator	supplied at customer's option	not provided	supplied at customer's option	with a rod rotator
Compatible with SAM Well Manager controller	yes			
Spudding mode	yes			



Contest diploma winner  
"100 Best Products of the  
Republic of Tatarstan"



Mode  
of well  
"spudding"

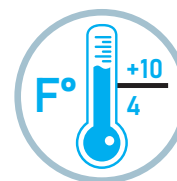

Operating  
temperature



Compatible with  
SAM Well Manager  
controller



## Purpose

The M1-X production packer, installed mechanically by compression or tension seating, is a retrievable packer allowing the tubing to be in tension, compression, or neutral position. This packer is specially intended for operation in aggressive downhole fluids during production and injection.

## Field of application

This packer is specially designed for use in production and injection wells, as well as in isolation of individual zones and a number of service operations upon well workover.

The service life of packers, taking into account the permanent location of the packer in the well, is up to 10 years.

## Advantages

- Additional tension seating method allows the packer to be used at shallow depths.
- Three assembly options available: standard pressure of 517 atm, large bore and high pressure of 690 atm.
- The tubing hanger can be left in a tension, compression, or neutral position.
- Holds the differential pressure above and below the packer.
- Seating by clockwise rotation, releasing by clockwise rotation.
- Bayonet seating and releasing mechanism of J-slot type.
- Internal bypass duct.
- The seal below the top wedges allows washing away the accumulated sludge during the packer release process.

## Packer specification

Packer schedule-size	Production string outside diameter, in.	Production string wall thickness, in.	Production string inside diameter (min), in.	Production string in-side diameter (max), in.	Packer outside diameter (max), in.	Packer inside diameter (min), in.	Connecting thread (box top—pin bottom)
5-1/2	5.7	0.3–0.37	5	5.14	4.81	2.36	2-7/8 EU 8Rd
6-5/8	6.61	0.35 – 0.42	5.8	5.92	5.59	2.36	2-7/8 EU 8Rd



# ENGINEERING AND CONSTRUCTION OF THE PROCESS TRAIN FOR DIAGNOSTICS AND REPAIR OF TUBING “TMC-HIGHTECH”

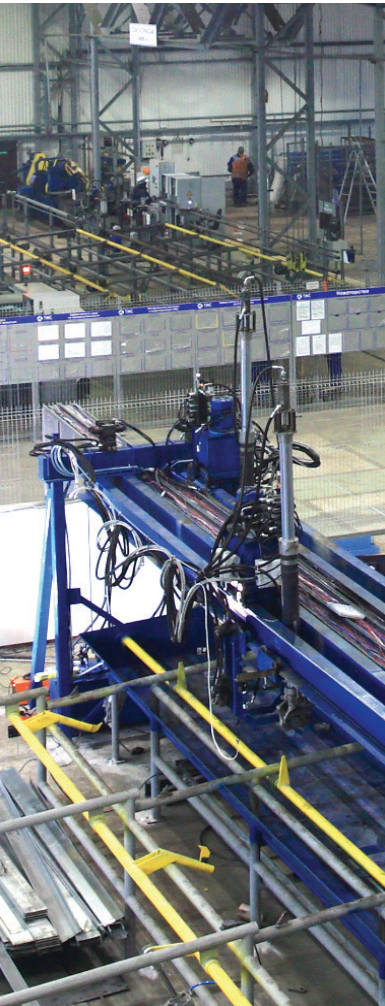

## Purpose

Automated process train for tubing diagnostics and repair “TMC-Hightech” (hereinafter referred to as the train) is designed for inspection and repair of onworn tubing strings (hereinafter referred to as tubing) as per GOST 633-80, GOST R 53366-2009, API Spec 5CT-2011, and GOST R 31446-2017 in order to determine their suitability for further use in the wells.

The train is used for washing and dressing of pipes from oil deposits, gauging with a cylindrical mandrel along the entire length of the pipes, visual-instrumentation control and sorting, output control, and other operations. The site allows to carry out inspection and repair of the main schedule-sizes of onworn tubing strings with diameters of 2.4, 2.9, 3.5 in. (4.0, 4.5 in.—upon the customer’s additional request); strength groups D, K, E, L, M, including process pipes wear-resistant clamps as well as pipes with the inner polymer corrosion-resistant coating.

Additionally, the train allows for manufacturing of new tubing from tube stock (“green”), owing to the availability of the necessary and sufficient pipe-threading machines and measuring instrumentation (hydrotesting, nondestructive testing units, etc.).

## Field of application

1. For oil and service companies that own a stock of onworn tubings that require diagnostics and repair in shop conditions.

2. For short-term assessment of tubing reusability in a simplified process train: tubing delivery from the well—washing—visual inspection—gauging—rejection and replacement—transferring to the well.
3. For nondestructive testing and hydraulic testing of tubing with pressure of 4,351/10,008 psi depending on customer’s requirements.
4. For manufacturing new tubing from tubular stock (“green”).

## Advantages

- High capacity of the process train—more than 850 tubing per day.
- High quality of tubing repair and production due to the use of state-of-the-art equipment, methods and technologies of diagnostics and repair field-tested by TMC Group Managing Company LLC.
- Compliance of repaired tubing quality characteristics with the requirements of GOST, Engineering Documentation and the customer’s regulatory technical documentation.
- Reduced interstage relocations—minimum time losses for transportation of pipes between sites owing to proper layout concept on equipment arrangement as per the value stream mapping (VSM), Pareto chart and workplace layout as per the “5S System”, as well as productivity enhancement and labor efficiency due to the application of lean production tools.

- A layout concept allowing to arrange the production within the required space of 20×60 m with the possibility of longitudinal transfer of pipes depending on the production site and customer requirements.
- Reduction of process waste when repairing threaded parts of tubing due to the possibility of adjusting the length of the defective pipe sections to be cut off and to reuse the tubing couplings.
- The use of an automated pipe body diagnostics line allowing to carry out the sorting of pipes by grades depending on the requirements (the range of controlled parameters is software-defined).
- Quick changeover when changing the schedule-size of pipes to be machined that takes no more than 30 minutes.
- Possibility of manufacturing related products on the train, such as subs and pup-joints.
- Additional equipment with the necessary equipment (as agreed with the customer).
- The own expertise of the Managing Company TMC Group LLC in design, upgrading, and construction of more than 20 process trains for tubing diagnostics and repair for maintenance facilities providing services for the largest Russian oil companies (PJSC Rosneft Oil Company, PJSC Lukoil, PJSC Tatneft, etc.) and their business units, as well as the experience in supplying Trains to PJSC Surgutneftegaz, PJSC Udmurtneft, RN-Remont NPO, TMC Group Managing Company LLC and others.



## Technical features

The train has a standard set of process equipment allowing to carry out the full-scale diagnostics and repair, as well as tubing manufacturing. List of process operations performed on the train:

1. Prewashing of the tubing pack from thick and liquid oil buildups (optional, not included in the delivery set).
2. Final washing of tubing from oil buildups in an automated hot-water tubing washing unit with a water recycling system.
3. Tubing drying (optional, not included in the delivery set).
4. Dressing of inner and outer surfaces of tubing—mechanized dressing.
5. Sorting, visual and instrumental inspection, and identification of defective and repairable tubing.
6. Gauging the inner cavity of pipes with a cylindrical mandrel to detect pipe curvature and local deformations of the body.
7. Screwing-off of coupling.
8. Non-destructive inspection of tubing (magneto-induction and magneto-acoustic methods of inspection for detecting defects and wall thickness of pipes).
9. Cutting off defective tubing sections on bandsaw machines (optional, not included in the delivery set).
10. Thread cutting as per GOST 633-80, GOST R 53366-2009, API Spec 5CT-2011, and GOST R 31446-2017 on CNC-controlled pipe-threading machines.
11. Thread inspection with gauges (optional, not included in the delivery set).
12. Screwing the coupling onto the pin with automatic torque control.
13. Hydraulic testing of pipes with internal fluid pressure as per GOST 633-80, GOST R 53366-2009, API Spec 5CT-2011, and GOST R 31446-2017 (up to 9.956 psi) and 10 sec. dwell time.
14. Drying of tubing after hydraulic testing (optional, not included in the delivery set).
15. Output inspection: length measurement, lubrication of threaded parts with preservative grease, installation of protective caps (protectors), impact marking, forming of bundles with finished products and documentation.
16. Automated bundling of finished products (optional, not included in the delivery set).
17. Follow-on operations and features. The pipe-threading machines are equipped with a steadyrest-loading line (included in the delivery set). Defective tubing ends are cut off by means of automatic bandsawing machines (optional, not included in the delivery set).
18. Moving tubings between operations, finished product warehouse and reject pockets by means of an automated conveyor system. The layout concept of the tubing repair area is designed in such a way as to minimize the path of pipe movement from the loading area to the, finished product warehouse. This allows for eliminating counterflows and congestions at sites and streamlining the movement of pipe up to the finished goods warehouse.
19. Other follow-on operations and related equipment are installed according to the specifications if necessary.

## Process train parameters

No.	Name	Parameter
1	Type of pipes to be processed	Tubing according to GOST 633-80, GOST R 53366-2009, API Spec 5CT-2011, and GOST R 31446-2017
2	Parameters of pipes to be processed:	
	- nominal outside diameter, in.	1.89; 2.36; 2.87; 2.87
	- maximum length, ft	36.09
	- minimum length, ft	18.04
3	Throughput capacity, pipes/hour	up to 40
	Production process automation degree (for the whole of the train, depending on customer requirements), %	up to 85 (at the customer's request)

## Production process and process train composition (basic operations)

No.	Name of basic operations	Production process characteristics	Equipment and tools
1	Washing a pipe bundle	Hot washing of outer and inner surfaces of pipes with a detergent solution at the temperature of up to 208,4° F	Pipe hot water washing installation
2	Rolling out of pipes	Rolling out the pipe bundle on the rolling table	Rolling-out table
5	Dressing the inner surface of the pipes	Mechanical pipe inner surface dressing with a tube cleaner	Installation for inner surface dressing
6	Dressing the outer surface of the pipes	Mechanical dressing of the outer surface of pipes with planetary brushes	Installation for outer surface dressing
7	Pipe inner cavity gauging	Inspection of tubing inner cavity as per GOST 633-80	Pipe wiper trip unit
8	Screwing-off of couplings	Performed mechanically on a coupling breaking machine	Coupling breaking machine
9	Nondestructive inspection	Non-destructive inspection of pipe body for longitudinal transverse defects and wall thickness	Tubing flaw detection unit
11	Mechanical processing	Threading as per GOST 633-80, GOST R 53366-2009, API Spec 5CT-2011, and GOST R 31446-2017	CNC pipe-threading machine (with steadyrests)—2 pc.
12	Thread inspection	Thread inspection with gauges	Gauges and mandrels (optional, not included in the delivery set)
13	Screwing down of couplings	Performed mechanically on a torque-controlled coupling screw-down machine	Coupling screw-down machine
14	Hydraulic testing	Pipe leak test by over-pressurization of fluid in the pipe inner cavity	Pipe hydraulic pressure tester
16	Pipe marking	Punch marking of each pipe, combined with a length-measuring installation	Pipe marking and length-measuring installation
17	Sorting pipes by strength group	Automated sorting of pipes by strength groups	Sorting cells
18	Interstage relocations	Moving pipes between operations, finished goods warehouse and reject pockets	Roller lines with polyurethane rollers, racks, accumulating pockets, transfer arms (lever-type), cabinets, control panels, cable products, etc.
19	Warehousing	Interstage storage of products	Reject accumulator, cells







# REPAIR OF TUBING



For comprehensive repair of tubing the state-of-the-art equipment is used, providing a full cycle of repair and restoration of tubing with an operational life increase. The repair technique includes the following operations:

- washing;
- pipe dressing;
- gauging;
- flaw detection;
- screwing-off of couplings;
- removal of defective sections of pipes;
- dressing and inspection of the threads;
- threading;
- making up of couplings of in-house production;
- hydraulic testing;
- length measurement;
- punch marking;
- completing with protective caps;
- formation of transportation bundles.



# ENGINEERING AND CONSTRUCTION OF THE PROCESS TRAIN FOR DIAGNOSTICS AND REPAIR OF SUCKER RODS “TMC-SR LINE”



## Purpose

The process train for diagnostics and repair of sucker rods “TMC-SR Line” (hereinafter referred to as the train) is designed to perform inspection and repair of onworn sucker rods (hereinafter referred to as SR), as well as incoming inspection of new ones, in order to determine their suitability for further use in the wells. The train is used for cleaning SR from oil buildups, cutoff of centralizers (if necessary), screwing-off of couplings, visual and instrumental inspection, non-destructive inspection of body and end parts, sorting and distribution by length, grades and schedule-sizes, coupling screwing-on, and output control. The site allows performing inspection and repair of onworn SR of schedule-sizes 0.75, 0.87, 0.98 in. and length from 23.62 to 29.99 ft.

Additionally, the train allows performing incoming inspection of new schedule-sizes 0.75, 0.87, 0.98 in. and length of 26.25 and 29.99 ft owing to the availability of the necessary and sufficient number of control and measuring equipment.

## Field of application

1. For oil and service companies that own a stock of sucker rods, both new and onworn, that require

comprehensive diagnostics and inspections in the shop conditions to determine the quality of the equipment supplied.

2. To assess the reusability of onworn sucker rods, sort them into grades based on the flaw detection results.
3. For non-destructive inspection of sucker rods and rod couplings by electromagnetic and eddy current methods, as well as with the use of magnetic particle methods of non-destructive inspection and luminescent suspensions.
4. For effective incoming inspection of brand-new rods on the basis of GOST 31825-2012, GOST 13877-96, which upon receipt of rods from various manufacturers can exclude the possibility of entry of brand-new bars with manufacturing defects.

## Advantages

- Increased performance of SR diagnostics and repair (more than 1,600 SR/day).
- High quality repair of SR threaded parts due to mechanization of dressing and instrumental inspection processes.

- Possibility of SR flaw detection with scratchalizers.
- High performance efficiency due to the organization of the single-piece flow.
- Process train compactness—52.49×105 ft.
- Rational arrangement of process equipment and workplace layout according to “5S System”, as well as productivity enhancement and labor efficiency due to application of lean production tools.
- Quick changeover when changing the schedule-size of SR to be machined that takes no more than 30 minutes.
- Additional equipment with the necessary equipment (as agreed with the customer).
- The expertise of the TMC Group Managing Company LLC in design, upgrading and construction of process trains for SR diagnostics and repair for maintenance facilities providing services for the largest Russian oil companies (PJSC Rosneft Oil Company, PJSC Lukoil, PJSC Tatneft, etc.) and their business units, as well as the experience in supplying Trains to PJSC Surgutneftegaz, PJSC Udmurtneft, RN-Remont NPO, TMC Group Managing Company LLC.





Winner of the competition  
"100 Best Goods of Russia"



Contest diploma winner  
"100 Best Products of the  
Republic of Tatarstan"



### Process sequence

The train has a standard set of process equipment allowing to carry out the full-scale diagnostics and repair of SR. List of process operations performed on the train:

1. Pre-sorting and rejection of SR determined by the results of visual inspection to be a irreparable reject. Preparation of suitable SR for feeding to a high-pressure washer or an activator-type washer.
2. Washing of SR free from oil buildups in a high-pressure washer or in an activator-type washer.
3. Screwing-off of rod couplings from SR.
4. Dressing SR with metal brushes on special-purpose equipment.

5. Visual and instrumental inspection of SR: body, threaded and fillet parts, thread calibration.
6. Ultrasonic testing of SR end pieces and body and sorting by grades and classes.
7. Screwing rod couplings on the shaft.
8. Output inspection: marking of SR, installation of protective caps (protectors), forming of bundles and documentation, transportation and warehousing of finished products.
9. Follow-on operations and features. Removal of scratchalizers and line-up clamps.
10. Follow-on operations and features. Straightening of SR by stretching and/or knurling in rolls.
11. Follow-on operations and features. SR fillet part surface layer strengthening.

12. Follow-on operations and features. Hardening SR.
13. Follow-on operations and features. Welding of scratchalizers and stationary line-up clamps and/or installation of movable line-up clamps.
14. Moving SR between operations, finished product warehouse and reject pockets by means of an automated conveyor system. The layout of the tubing repair area is designed in such a way as to minimize the SR travel distance from the loading area to the finished product warehouse. This eliminates counter flows and congestion at the sites, and streamlines the SR movement to the finished product warehouse.
15. Other follow-on operations and related equipment are installed according to the specifications if necessary.

### Process train parameters

No.	Name	Parameter
1	Type of SR to be processed	SR as per GOST 31825-2012, GOST 13877-96 and their imported analogues
2	Parameters of SR to be processed	
	schedule-size, in.	0.63; 0.75, 0.87, 0.98
	maximum length, ft	29.99
	minimum length (except for shorter length SR), ft	23.62
3	Throughput capacity, SR/day	up to 1,600 (for one set of the train)

### Production process and process train composition (basic operations)

No.	Name of basic operations	Equipment and tools
1	Pre-sorting and preparation of SR for feeding to the high-pressure washer	Pre-sorting rack
2	Rod washing	High-pressure washer
3	Screwing-off of rod couplings from sucker rods	Installing the coupling rotor
4	Dressing SR with metal brushes	Machines for mechanized SR thread dressing
5	Visual and instrumental inspection of SR	SR thread instrumental control station
6	SR end piece ultrasonic testing	UT
7	Non-destructive inspection of SR body	Sucker rod flaw detection unit
8	Removing the scratchalizers from rods	scratchalizer cutoff table
9	Straightening of rods by stretching (if necessary)	RSI (rod straightening installation)
10	Straightening of rods by knurling in rolls (if necessary)	Rod straightening knurling unit
11	SR fillet part surface layer strengthening	Fillet part reeling installation
12	Marking of finished products	Laser marker
13	Transportation of finished products	Independently-driven transfer carriage
14	SR stagewise transfer	Transportation system, pockets, intermediate racks
15	Rod quenching (if necessary)	Sucker rod heat treatment plant





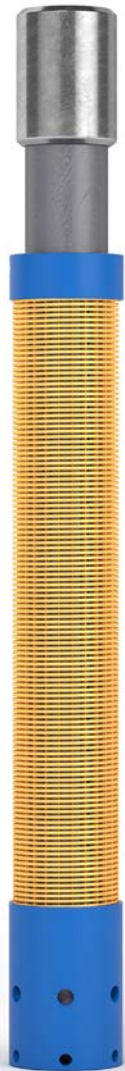

## Purpose

Cartridge sucker-rod pump filter CSRPF is designed to improve the operational reliability of sucker-rod pumps by filtering the produced oil-well fluid from mechanical impurities.

## Composition

The filter is a prefabricated structure consisting of a filter base, with a freely moving spool piece therein, wherein one spiral-slot filter element and a perforated tube are fixed by means of a socket and a retention screw.

If necessary, the filter design allows multiple filters to be assembled into one. For this purpose, unscrew the retention screws securing the adapter and the base. Then connect the free end of one filter pipe to the socket of the other filter. Thus, up to 10 filters can be combined.

## Principle of operation

The fluid coming to the pump intake from the well is purified from mechanical particles by a filtering element made of triangular stainless-steel profile of AISI 316 grade, which is spirally wound with a certain pitch on stringers and provides a rigid screen with longitudinal slots of strictly defined clearance. In the lower part of the filter, in the filter housing recess, there is a spool piece, which comes into operation in case of heavy clogging of the filter element. Due to the pressure difference inside the filter housing and in the plug under the spool piece, the spool piece moves upward until the hole is aligned with the slot in the spool piece.

The reciprocation of the spool piece, caused by the movement of the produced fluid, ensures the self-purification of the filter.

## Technical features

Name	Outer diameter D, in.	Length of filter assembly L, in.	Length of perforation L1, in.	Thread type	Slot width, in.
Filter CSRPF	1.26	18.7	11.81	G 3/4"	0.01-0.05
Filter CSRPF	1.65	18.7	11.81	G 1"	0.01-0.05
Filter CSRPF	2.17	18.7	11.81	G1 1/4"	0.01-0.05



# SLOTTED DOWNHOLE FILTERS SLIDE™ (SDF)



## Field of application

The slotted filter SLIDE™ is used to filter the extracted product from foreign matter and ingress of mechanical impurities.

## Advantages

- Sustained full-cycle throughput with self-purification capability.
- Stable operation of downhole pumping equipment due to increased filtration surface.
- Low clogging of the filtering element due to the unstable position of mechanical particles on the filtering surface and the cleanliness of the wedge profile surface.
- High axial and radial structural capability (up to 1,918 lbsf·ft) due to the increased number of bearing elements.
- High corrosion resistance and resistance to aggressive action of acid-alkali agents.

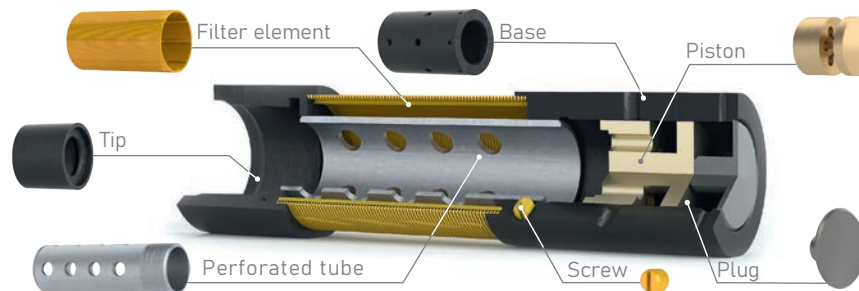

## Principle of operation

- The fluid coming to the pump intake from the well is purified from mechanical particles, passing through the filter element made of stainless-steel wedge profile of AISI 304, AISI 316 grade, which is spirally wound with a certain pitch on bearing elements to provide a rigid screen with longitudinal slots of strictly defined clearance. Sharp edges create an arch (sand bridge) over certain slot sections, thus maintaining the permeability over these sections.
- In the lower part of the filter, in the filter housing recess, there is a spool piece, which comes into operation in case of total clogging of the filter element. Due to the pressure difference inside the filter housing and in the plug under the spool piece, the spool piece moves upward until the hole is aligned with the slot in the spool piece. The reciprocation of the spool piece, caused by the movement of the produced fluid, ensures the filter self-purification of foreign matter.

## Technical features

Pipe outside diameter D, in. (73-273)	1.89	2.36	73 (2.87)	89 (3.50)
Wall thickness S, in.	according to the customer's terms of reference			
Thread type	GOST 633-80			
Tube length L, in.	up to 472.4			
Filter element length l, in. (overall)	up to 393.7			
Clearance between the filter element coils, b, in.	from 0.0039±0.0015 to 0.19±0.0015			
Diameter of holes in the caps d, in.*	0.32 to 0.79			
Number of holes per 1 linear meter*	not more than 36 per linear meter			
Outside diameter of the coupling D1, NOV, in.*	2.2	2.87	3.5	4.2
Spool piece presence	according to the customer's terms of reference			

\* dimensions according to the customer's terms of reference

# PRODUCTION OF TUBING AS PER GOST 633-80, GOST 31446-2017



## Purpose

Tubings are used in the operation of oil and gas wells to transport fluids and gases inside the casing, as well as for repair and round-trip operations.

## The pipe manufacturing process includes the entire set of operations

- 100% incoming inspection of tube stock from reliable suppliers.
- Gauging with high-precision gauges.
- Thread cutting and hardening.
- Complete with couplings of required strength class.
- Supply of pipes with Premium® type threads.
- 100% non-destructive inspection of tubing (flaw detection).
- Hydrotesting with Pmax up to 14,223 psi.
- Application of internal protective polymer coatings.
- 100% finished-goods inspection
- Packaging and marking according to customer requirements.

## Technical features

Outside diameter, in.	Wall thickness, in.	Length, ft	Strength group	Thread type	Coating thickness, μ-in.
1.89-3.50	0.16-0.37	27.89-34.45	D, K, E, L, M J55, K72, L80, N80, T95, P110	conical triangular	up to 0.028



Winner of the competition  
"100 Best Goods of Russia"



Contest diploma winner  
"100 Best Products of the  
Republic of Tatarstan"

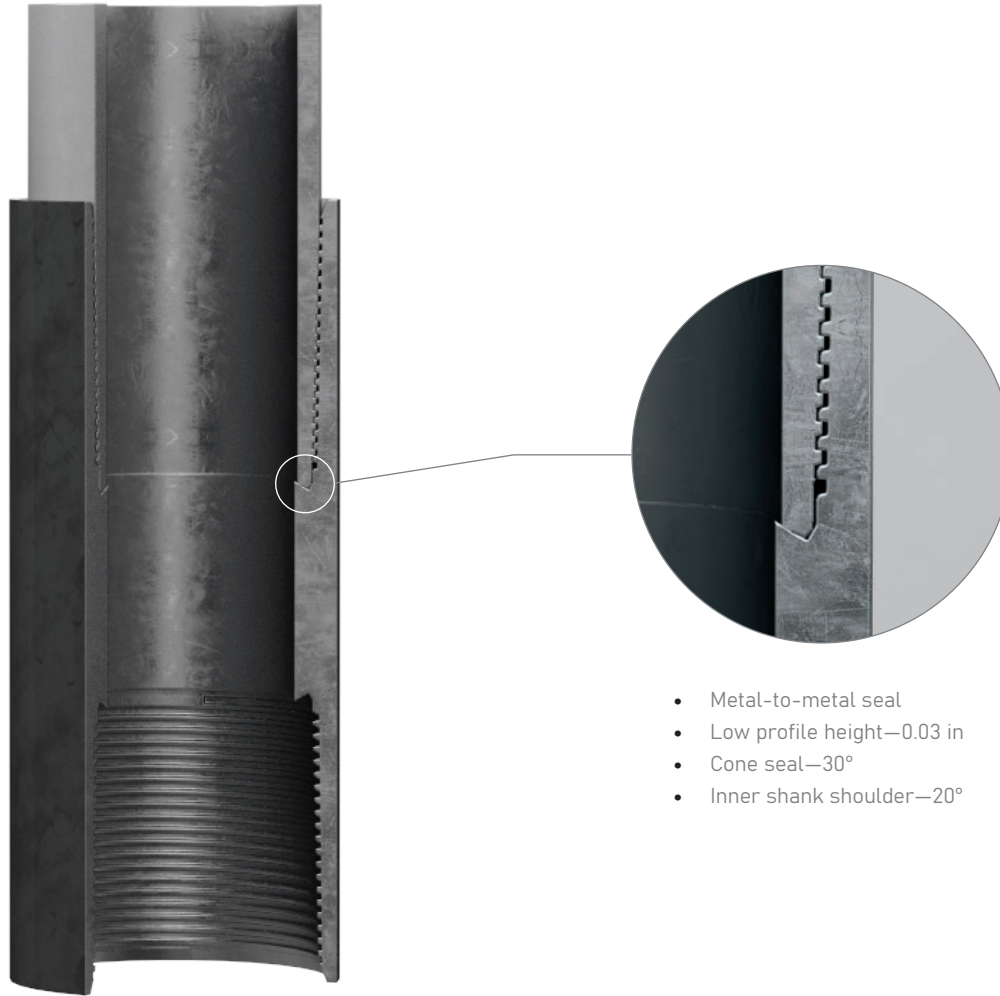

- Metal-to-metal seal
- Low profile height—0.03 in
- Cone seal—30°
- Inner shank shoulder—20°

## Purpose

HKF-G premium threaded tubing is used in oil, gas, and gas condensate production. This class of joints is characterized by high strength, and resistance to tensile, bending and compressive loads with excessive torque.

## Field of application

The test results of premium threaded pipes show that such threaded connections are absolutely leak-proof under various loads, which can be considered as their most important characteristic when working in aggressive environments.

The metal-to-metal sealing ensures the pipe-end contact and the required pressure in the sealing zone ensuring 100% gas-tightness. The inner shank shoulder increases the contact pressure in the sealing zone and acts as a make-up stop.

The low profile (0.03 in.) thread design ensures easy screwing of the thread connection. The connection inner cavity smooth profile ensures a flush joint and good conditions for the application of protective anti-corrosion coatings.



### Advantages of NKS-G threaded connection

- Heavy-duty service of oil and gas wells.
- Protection against excessive make-up torque.
- Resistance to bending loads.
- Sealing of metal-to-metal threaded joints.
- High durability.

### Main technical features of the threaded joint HKF-G 2.87 in. of strength group “K”

No.	Technical features	Units	Value
1	Axial load corresponding to the tubing body tensile strength	kibf	181.2
2	Load corresponding to the HKF-G threaded joint yield strength	kibf	130.8
3	Make-up torque	lbf-ft	2.213
4	Value of tubing hydraulic testing at which stress in the pipe reaches the yield strength	psi	9.660



Winner of the competition  
“100 Best Goods of Russia”



Contest diploma winner  
“100 Best Products of the  
Republic of Tatarstan”

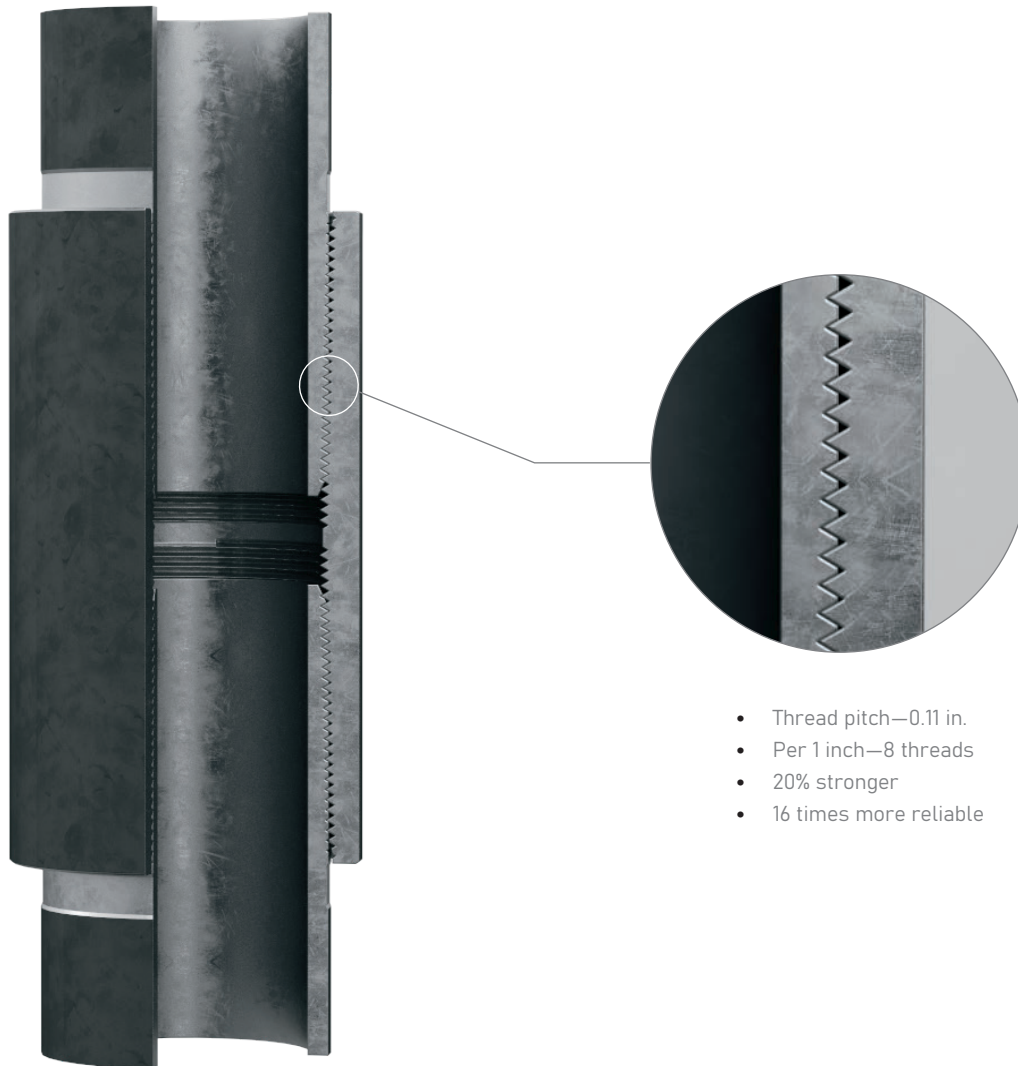

## Purpose

High-strength wear-resistant HKF thread is used on tubing for process operations in oil and gas wells with abnormal operating conditions.

HKF threads have an elongated design and are characterized by improved strength characteristics.

## Field of application

NKF-threaded joints, unlike conventional triangular HKF threads as per GOST 633-80, have an elongated design, resulting in high strength characteristics, allowing the use of pipes with this thread type for process operations in wells, incl. hydraulic fracturing of formation

## Advantages of the NKF-threaded joint

- The bearing capacity of HKF-threaded joint is 20% higher than conventional tubing as per GOST 633-80
- HKF-threaded pipes are 15% cheaper than hardened upset-end pipes.
- The lifetime of HKF threads is 16 times higher than conventional threads.
- Thread misalignment is eliminated due to the increased free thread run-in into the coupling.

### Ultimate joint strength and recommended torque values for making up pipes

Nominal pipe diameter, in.	Thread schedule-size	Wall thickness, in.	Strength group					
			D	K	E	L	M	R
Ultimate joint strength in the thread, Qult, kipf								
2.87	F-3.2	0.2	71.71	92.8	104.3	123.6	136.7	175.6
		0.3	95.9	124.3	139.6	165.5	183.2	235.2
89 (3.50)	F-3.2	0.26	109	141.4	158.9	188.2	208.4	267.5
		0.31	138.9	180.1	202.3	239.9	265.3	340.8
Make-up torque, lbsf-ft								
73 (2.87)	F-3.2	0.2	1.313	1.519	1.623	1.844	2.036	2.552
		0.3	1.733	1.991	2.139	2.434	2.699	3.393
89 (3.50)	F-3.2	0.26	1.564	1.881	2.176	2.581	2.803	3.577
		0.31	1.881	2.463	2.773	3.290	3.636	4.647



Winner of the competition  
"100 Best Goods of Russia"



Contest diploma winner  
"100 Best Products of the  
Republic of Tatarstan"



## Purpose

The couplings are intended to join tubings into a single line to transport fluids in oil wells.

## Field of application

Tubing couplings are made as per GOST 633-80, GOST 31446-2017 from seamless hot-rolled pipes with permanent quality control on state-of-the-art equipment of leading manufacturers.

## Advantages

- Production of couplings according to specific requirements of the customer.
- Production of couplings with various coating options: powder coating, phosphatizing, thermomdiffusion galvanizing.
- Production of couplings of any strength group as per GOST 632-80, GOST 633-80, and GOST 31446-2017 (analogue of API spec 5CT).

## Technical features

### GOST 633-80 couplings for smooth tubing

Nominal pipe diameter, in.	Outside diameter, in.	Length, in.	Weight, lb	Strength groups
1.89	2.2	3.78	1.1	D, K, E
2.4	2.9	4.3	2.9	D, K, E, L
2.9	3.5	5.2	5.3	D, K, E, L
3.5	4.3	5.7	7.9	D, K, E, L
4.0	4.7	5.9	9.9	D, K, E, L
4.5	5.2	6.1	11.2	D, K, E, L

### GOST 633-80 couplings for external upset tubings

Nominal pipe diameter, in.	Outside diameter, in.	Length, in.	Weight, lb	Strength groups
1.89	2.5	3.94	1.7	D, K, E
2.4	3.0	4.9	3.3	D, K, E, L
2.9	3.6	5.3	6.2	D, K, E, L
3.50	4.5	5.7	9.2	D, K, E, L
4.0	5	6.0	11.0	D, K, E, L
4.5	5.5	6.3	13.9	D, K, E, L

### GOST 31446-2017 tubing couplings

Nominal pipe diameter, in.	Outside diameter, in.	Length, in.	Weight, lb	Strength groups
1.89	2.2	3.7	1.2	-
2.4	2.8	4.2	2.8	-
2.9	3.5	5.1	5.1	-
3.50	4.2	5.6	8.2	-
4.0	4.7	5.7	9.6	-
4.5	5.2	6.1	4.167	-



## Purpose

The sub is intended to join tubings of various diameters and thread types, as well as subsurface equipment that has connector ends with tubing threads used in operation of oil and gas wells.

## Technical features

There are three types of subs:

- Type P (transitional) sub, a combination of threaded elements of box-to-pin type.
- Type M (coupling) sub, a combination of threaded elements of box-to-box type.
- Type H (pin) sub, a combination of threaded elements of pin-to-pin type.

The tubing sub is certified and manufactured with geometric parameters according to GOST 23979-80 from steel, providing mechanical properties of the corresponding category of pipe material strength as per GOST 633-80. Strength groups: "D", "K", "E", "L".

## Technical features

Nominal pipe diameter, in.	Pipe				Coupling		
	Outside diameter, in.	Wall thickness, in.	Inside diameter, in.	Weight of 1 m, lb	Outside diameter, in.	Length, Lm	Weight, lb
1.29	1.31	0.14	1.04	5.7	1.6	3.3	0.88
1.65	1.6	0.14	1.39	7.3	2.06	3.54	0.88
1.89	1.9	0.16	1.59	9.7	2.2	3.78	1.1
2.4	2.37	11.0	1.98	14.99	2.9	4.3	2.9
2.9	2.9	0.2	2.44	20.28	3.5	5.2	5.3
		0.3	2.3	25.13			
3.50	3.5	0.26	2.99	29.1	4.2	5.7	7.9
4.0	4	0.26	3.29	33.51	4.7	5.9	9.9
4.5	4.5	0.3	3.9	40.8	5.2	6.1	11.24



Drill site UPA 60-80

The company manufactures packaged, capacitive equipment, non-standard parts, and metal structures of in-house design and according to the customer's design documentation.



Control assembly of the echelon-type drill-rig circulation system



## Purpose

They are intended to receive, accumulate, and dispense tubing and sucker rods during well repair.

- It is designed to be used under moderate climate conditions at ambient temperature from +104 to -49 °F according to GOST 16350.
- Climatic version U2 according to GOST 15150.
- Production and delivery under TU 02.180.053-01.

The racks consist of a base made in the form of a sledge, on which the left rack for accumulation of downhole tubular, and the right rack for accumulation of tubing and sucker rods, are mounted. The base tail end is equipped with a pair of wheels, which allows easy transportation of the racks. The racks can be equipped with a derrick floor at the customer's request. The height of the derrick floor is adjustable by means of a lifting mechanism and piers.

## Technical features

Parameters	PM-25	PKS-60	UNS 1-20
Total maximum permissible load on the left and right racks, t	25	60	20
Overall dimensions in transport position, in.:			
- length	413.4	86.61	433.1
- width	94.5	94.5	98.4
- height	1.623	1.623	89.4
Weight, lb	8.267	8.488	9.480
Specification under designation	RBT 657.00.000	RBSH 2947.00.000	BPO 21.00.00.000

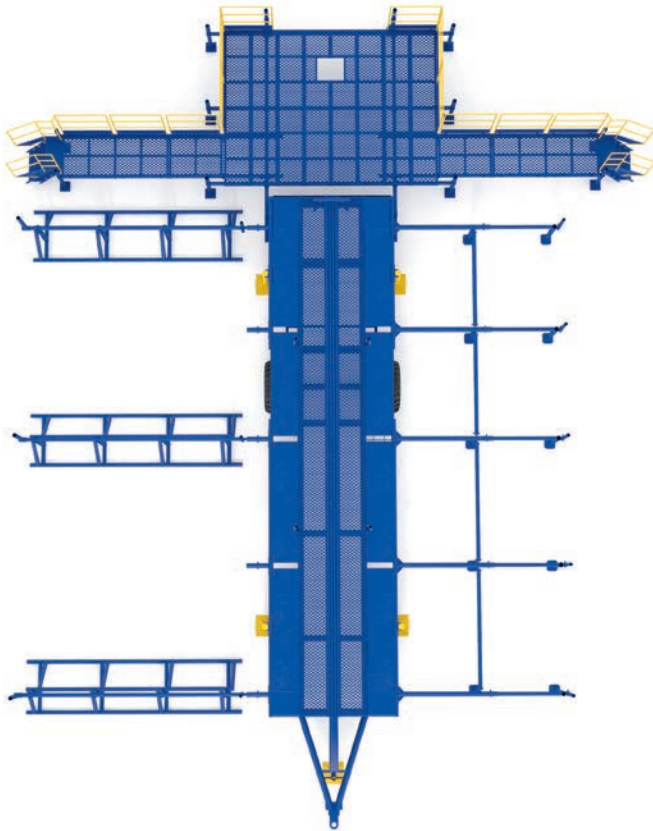



# DRILLING EQUIPMENT

## DRILLING EQUIPMENT

- 60 HIGH-STRENGTH HIGH-TORQUE CASING PIPE TMC-OTV-6,35
- 62 CASING PIPE TMC1-SRV HIGH-TORQUE HIGH-HERMETIC
- 64 CASING PIPE TMC1-SRV2 HIGH-TORQUE HIGH-HERMETIC
- 66 HEAVY DUTY CASING PIPE WITH BUTTRESS PROFILE
- 68 EXTREME-LINE CASING PIPE N-S.\*BM FLUSH-JOINT HIGH-HERMETIC
- 70 CASING COUPLINGS
- 72 DRILL PIPE REPAIR
- 74 DRILL PIPE SUBS
- 75 Flash weld tool joints
- 76 TYPES OF REPAIRABLE THREADED JOINTS
- 77 LOCKING RING
- 78 STRING SHOE WITH BKPOK CHECK VALVE AS PER
- 79 STRING SHOE OF BK-P AND BKM TYPE
- 80 STRING SHOE WITH BKO CHECK VALVE
- 81 REPAIR OF HYDRAULIC AND PNEUMATIC TONGS
- 82 DRILLING EQUIPMENT REPAIR
- 84 REPAIR, MAINTENANCE AND TESTING OF BLOWOUT PREVENTION EQUIPMENT

# HIGH-STRENGTH HIGH-TORQUE CASING PIPE TMC-OTV-6,35

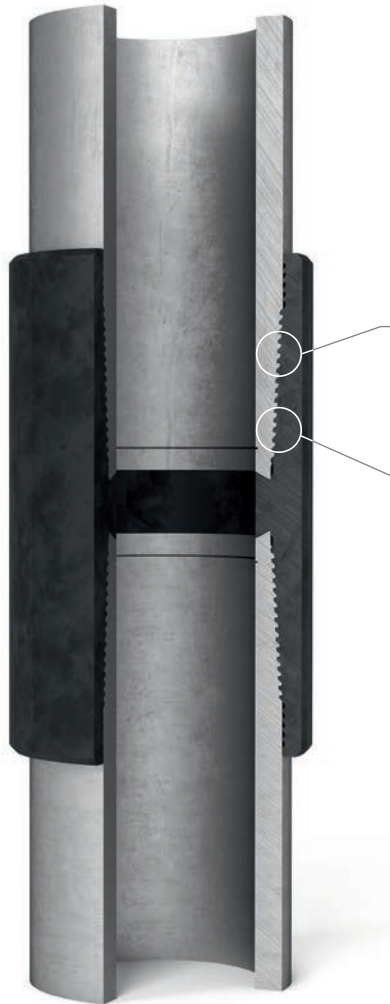

The company produces premium class casing pipes with threaded joints of TMC-OTV-6,35-245, TMC1-CPV, TMC1-CPV2 type and casing pipes as per GOST 632-80 and TU 14-ZR-29-2000 with threaded joints of OTTM, OTTG, BUTTRESS type.

The pipe manufacturing process includes the entire set of operations: incoming inspection of tube stock, gauging, threading, coupling makeup, hydro-testing, marking, and packaging. The pipe production process incorporates a quality system in accordance with the requirements of ISO 9001:2015. Pipe production lines are equipped with state-of-the-art process and control equipment.

Pipes and couplings thereto are subjected to non-destructive inspection in accordance with the requirements of applicable standards. All pipes are paint-marked and punch-marked in accordance with the requirements of existing regulatory and technical documentation. Pipes are supplied with threaded joint protection and in bundles equipped with load-gripping clamps.

## Purpose

Borehole wall lining after drilling, overlapping and isolation of oil-, gas- and water-bearing formations and interlayers from each other.

## Field of application

OTV series casings are used for lining oil and gas wells with a complex profile, as well as wells where coolant is transported at temperatures up to 482 °F.

The unique design consists in sealing of the threaded joint due to interference contact at the pin toroidal seal band with the tapered bore in the box.

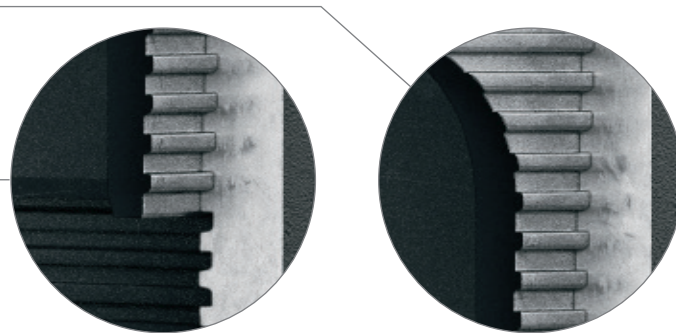

## Technical features

Type of threaded joint	Nomenclature of pipe, D—t, in.	Strength group as per GOST 632-80 / API 5CT
TMC Premium joints		
TMC-OTV-6.35-245	9.65-0.35; 9.65-0.39	D, E, L, M
TMC1-SRV	6.61-0.35	D (A) / J55
TMC1-SRV2	9.65-0.35	E / N80
connections as per GOST and TU		
BUTTRESS	as per TU 14-ZR-29-2000	D, E, L, M
OTTM	as per GOST 632-80	D, E, L, M
OTTG	as per GOST 632-80	D, E, L, M

### Advantages of the threaded joint

- Improving the quality of pipe assembly on the well by free run-in without pin rotation into the box to the depth of 12 threads, which reduces the possibility of thread misalignment and ensures the screwed pipe load distribution over several mutually contacting threads.
- Increasing the axial tensile and compressive loads in the threaded joint almost to the load that the casing body can withstand. The load is increased due to its redistribution to the threads of an incomplete profile at section g, which increases the cross-sectional area of the metal.
- Axial load uniform distribution across the threads by gradually increasing the depth of the thread from the indicating belt (5) to the main plane.
- Easier visual check of thread makeup end by aligning the coupling end with the beginning of the wide circular band (5).
- Improvement of casing reliability when running into highly deflected wells by optimizing the clearances near the threads and toroidal-conical design of the threaded joint sealing unit.

### Technical features

Pipe outside diameter, in.	Pipe wall thickness, in.	Make-up torque, lbsf-ft, for strength group														
		D, j55, K55			E, N80			L			M			R		
		M min.	M total	M max	M min.	M total	M max	M min.	M total	M max	M min.	M total	M max	M min.	M total	M max
9.6	0.35	12.022	13.276	14.751	13.866	14.603	15.267	14.825	16.447	18.070	16.521	18.365	20.135	16.521	18.365	20.135
	0.39	13.350	14.898	16.226	14.677	16.300	17.996	15.931	17.701	19.471	18.439	20.504	22.569	18.439	20.504	18.439
	0.44	14.751	16.374	17.996	16.447	18.291	20.061	17.554	19.545	21.463	20.578	22.864	25.077	20.578	22.864	25.077
	0.47	16.300	18.070	19.324	18.144	20.135	22.126	18.734	20.799	22.864	22.569	25.077	27.289	22.569	25.077	27.289
	0.54	17.922	19.914	21.905	19.914	22.126	24.192	21.241	23.601	24.708	24.560	27.289	29.502	24.560	27.289	29.502
0.63	17.922	19.914	21.905	19.914	22.126	24.192	21.241	23.601	24.708	24.560	27.289	29.502	24.560	27.289	29.502	

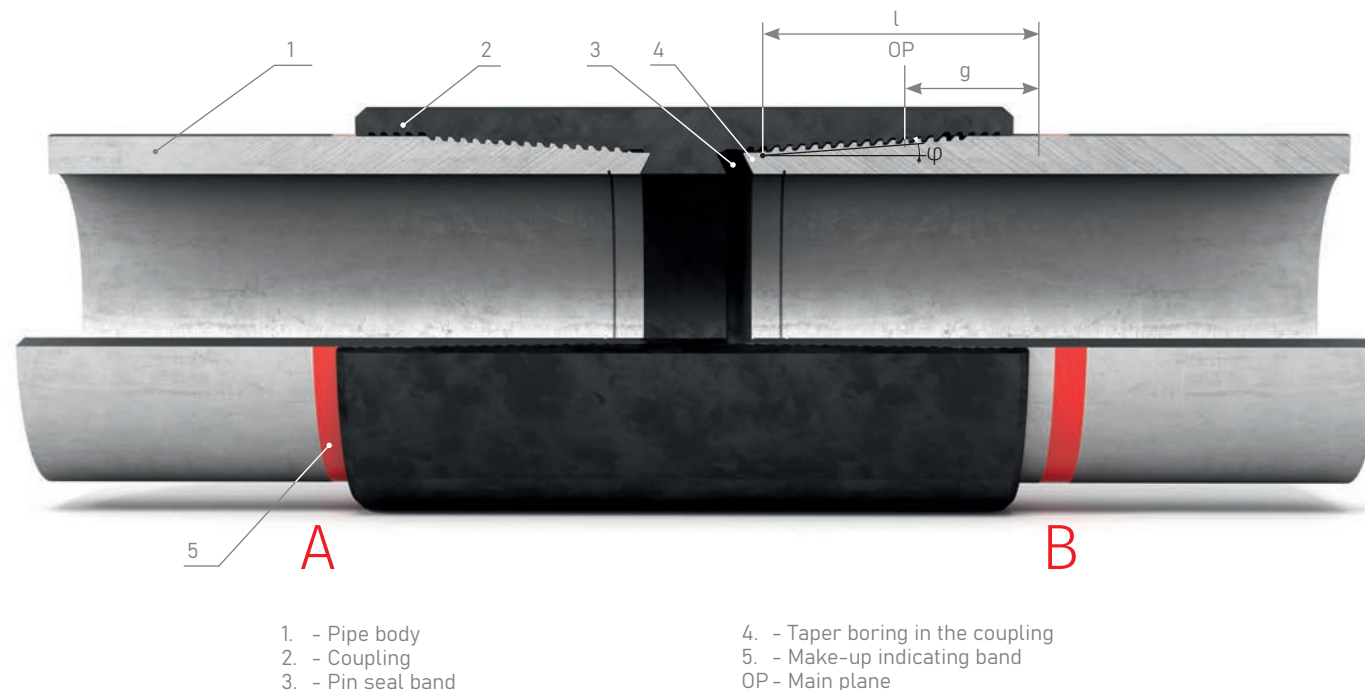

Winner of the competition "100 Best Goods of Russia"



Contest diploma winner "100 Best Products of the Republic of Tatarstan"

- Pipe body
- Coupling
- Pin seal band

- Taper boring in the coupling
- Make-up indicating band
- Main plane

# CASING PIPE TMC1-SRV HIGH-TORQUE HIGH-HERMETIC

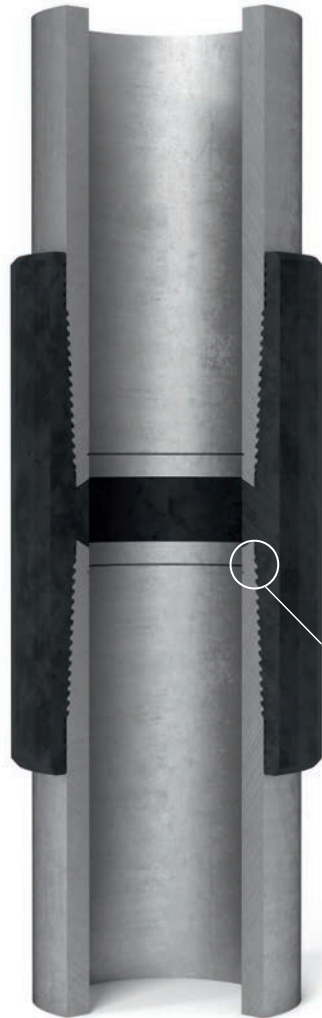

## Purpose

Borehole wall lining after drilling, overlapping and isolation of oil-, gas- and water-bearing formations and interlayers from each other.

## Field of application

The company manufactures TMC1-SPV casing pipes as per TU, which are used for lining of oil and gas wells with a complex profile.

## Advantages

- Hermetic geometric mating of the threaded profile and the two thrust elements.
- High make-up torque (up to 20.283 lbf-ft).
- Maintaining tightness under the action of combined tensile loads (up to 379.9 kipf), compression (at least 80%) and internal hydraulic pressure (up to 5.076 psi) due to additional thrust element, rotation with simultaneous cementing.

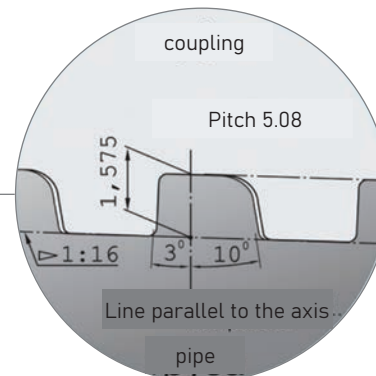

- Thread pitch—0.2 in.
- Seal—torus—metal-to-metal
- 5 threads per 1 inch

## Design features of the threaded joint:

1. Pipe thread is cut as per the manufacturing analogues according to GOST 632-80 and GOST R 31446-2017 (analogue of API Spec 5CT) and furthermore a sealing thrust element is made, which provides a joint geometric mating of threaded profile and two thrust elements (ledge on the pipe and boring in the coupling) "metal-metal".
2. When the threaded profile and the sealing thrust elements are mated together, there is no clearance between the seal outer surface on the pipe pin and in the bore in the coupling. The geometric sealing takes place by geometric dimensions of thread profile mating angles, pin end and in the boring—by the coupling face as metal-to-metal, as well as by the diameters of the sealing elements. The presence of two turns of incomplete thread profile on the sealing diameter surface of the pipe pin sealing element is a dampener during operation of the joint and a distinctive geometry feature—the brand of MC TMC Group Managing Company LLC. After three times of joint makeup-breakout the incomplete profile turns disappear from the surface of the seal.
3. The joint makes it possible to significantly increase make-up torques and the bearing capacity of the threaded joint, as well as increases reliability under the action of combined loads in the form of tension, compression, and internal hydraulic pressure.



## Technical features

Pipe out-side diameter	Pipe wall thickness, in.	Make-up torque, lbf-ft, for strength group														
		D, J55, K55			E, N80			L			M			R		
		M min.	M total	M max	M min.	M total	M max	M min.	M total	M max	M min.	M total	M max	M min.	M total	M max
6.63	0.35	12.907	14.309	15.710	14.751	14.439	22.126	19.398	21.537	23.713	21.758	24.192	26.552	24.413	27.142	29.871
	0.36	14.161	15.710	17.259	16.226	20.283	24.340	21.241	23.676	26.036	23.971	26.552	29.207	26.847	29.871	32.822
	0.47	18.365	20.430	22.422	21.094	26.331	31.641	27.585	30.756	33.854	30.388	33.412	31.051	32.084	33.190	34.075
9.6	0.35	11.875	13.202	14.530	13.866	14.604	15.268	15.268	16.964	18.808	18.070	19.914	21.905	20.135	21.758	23.971
	0.39	13.077	14.530	15.931	14.272	15.858	17.406	16.743	18.365	20.209	19.840	21.389	23.823	21.832	22.717	25.151
	0.44	13.202	15.415	16.743	15.931	17.701	19.545	16.669	18.513	20.357	20.061	22.348	24.708	20.283	23.601	25.962
	0.47	14.198	15.784	17.185	18.218	20.357	22.311	19.103	21.241	23.601	22.274	24.560	26.552	23.897	26.626	29.281
	0.54	15.341	17.111	18.808	19.767	21.979	24.118	21.758	23.012	25.298	23.159	26.626	28.175	25.888	28.765	24.856
	0.63	16.079	17.849	19.767	22.717	25.298	27.806	23.307	25.815	27.880	25.888	28.544	30.683	31.936	33.264	34.813
12.75	0.33	19.324	21.389	22.643	28.027	33.412	29.650	29.871	33.190	35.698	29.871	33.190	35.698	29.871	33.190	35.698
	0.37	21.537	23.897	26.257	29.724	33.117	35.919	29.871	33.190	35.698	29.871	33.190	35.698	29.871	33.190	35.698
	0.43	24.782	27.659	30.388	29.798	33.190	36.214	29.871	33.190	35.698	29.871	33.190	35.698	29.871	33.190	35.698
	0.49	28.101	31.199	34.297	29.798	33.190	36.214	29.871	33.190	35.698	29.871	33.190	35.698	29.871	33.190	35.698
	0.55	29.724	33.190	36.436	29.798	33.190	36.214	29.871	33.190	35.698	29.871	33.190	35.698	29.871	33.190	35.698



Winner of the competition  
"100 Best Goods of Russia"



Contest diploma winner  
"100 Best Products of the  
Republic of Tatarstan"

# CASING PIPE TMC1-SRV2 HIGH-TORQUE HIGH-HERMETIC



## Purpose

Borehole wall lining after drilling, overlapping and isolation of oil-, gas- and water-bearing formations and interlayers from each other.

## Field of application

TMC1-SPV2 casing pipes are used for extraction of super-viscous oil by steam-assisted gravity drainage (SAGD), which involves drilling two parallel horizontal boreholes—for steam injection into the formation and cracking of viscous oil, as well as for oil extraction.

## Unique design

This connection is characterized by high compression, tension and bending capacity and meets the requirements level (the highest level of connections application) of GOST R ISO 13679-2016 (analogue of ISO 13679:2002 Petroleum And Natural Gas Industries-procedures For Testing Casing And Tubing Connection), which confirms the possibility of its use in the most difficult conditions of oil production. Furthermore, a feature of the TMC1-SRV2 threaded connection is that it can be assembled on an inclined rig mast.

- Thread pitch—0.25 in.
- Seal—torus—metal-to-metal
- 4 threads per 1 inch

## Advantages of the threaded joint

- A thread profile is cut on the pipe and an additional sealing thrust element is made, which provides a joint geometric mating of the threaded profile and the sealing unit along two toroidal metal-to-metal surfaces.
- When the threaded profile and the sealing thrust elements are mated together, there is no clearance between the seal outer surface on the pipe pin and in the bore in the coupling. The geometric sealing takes place by geometric dimensions of thread profile mating angles, the pin end, and the toroidal seal.
- The connection makes it possible to significantly increase make-up torques and the bearing capacity of the threaded connection joint, as well as increases reliability under the combined effects of tension, compression and internal hydraulic pressures.
- The torque value is different from the minimum, optimum, and maximum Mkr. For 9.65×0.35 in. casing - Mkr = 30.978 lbsf-ft.

### Strength group as per GOST 632-80 / API 5CT

Strength group	D	E	L	M
Ultimate tensile strength, $\sigma_v$ , ksi, not less	95	99.93	109.9	125
Yield strength $\sigma_v$ , ksi not less NOV	54.97 80.06	80.06 109.9	95 123.6	109.9 140
Percentage elongation, $\delta_5$ , %, not less	14.3	13.0	12.3	10.8

### Technical features

Pipe out-side diameter	Pipe wall thickness, in.	Make-up torque, lbf-ft, for strength group														
		D, j55, K55			E, N80			L			M			R		
		M min.	M total	M max	M min.	M total	M max	M min.	M total	M max	M min.	M total	M max	M min.	M total	M max
9.6	0.35	19.324	21.463	23.601	25.092	27.880	30.978	27.585	30.683	33.707	30.314	33.707	34.665	30.314	33.707	34.665
	0.39	20.135	22.643	24.413	26.847	29.502	32.453	29.207	32.453	35.698	31.863	35.403	36.141	31.863	35.403	36.141
	0.44	20.135	22.717	24.487	26.847	29.576	32.526	29.945	33.264	36.583	31.936	35.550	36.141	31.936	35.550	36.141
	0.47	20.652	23.233	25.815	27.289	30.019	33.190	29.945	33.264	36.583	31.936	35.550	36.141	31.936	35.550	36.141
	0.54	20.652	23.601	25.815	27.289	30.240	33.559	29.945	33.264	36.583	31.936	35.550	36.141	31.936	35.550	36.141
	0.63	20.652	23.601	25.815	27.290	30.240	33.559	29.945	33.264	36.583	31.936	35.550	36.141	31.936	35.550	36.141

# HEAVY DUTY CASING PIPE WITH BUTTRESS PROFILE



## Field of application

Casing coupling joint with buttress thread is intended for construction and operation of vertical wells of oil, gas and gas condensate fields. The BUTTRESS connection combines the functions of a "travel screw" and a hydraulic connection seal, providing good connection reliability compared with analogues.

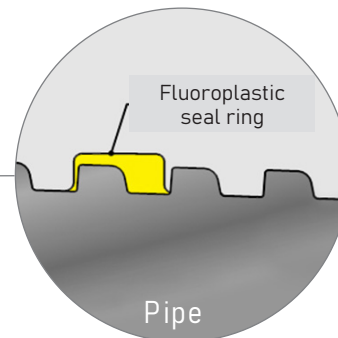
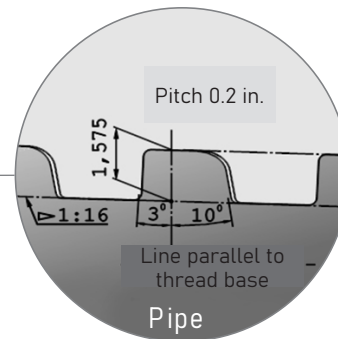

## Design features of threaded joint

1. Taking increased axial loads in one direction. The thread shape allows reducing the friction factor and doubles the shear resistance due to the increased profile.
2. The design feature of BUTTRESS threaded casing is the high resistance of the threaded joint to tensile loads. The BUTTRESS thread profile has a shape of an inequilateral trapezoidal (pitch 0.2 in., taper 1:16). The stab flank, which takes the load at the moment of placing the pipe pin into the box part, and works in compression, is made at an angle of 10°, which provides an easy placing the pipe into the coupling and reduces the thread jamming.
3. The three-degree deviation of the profile bearing side makes allows reducing the risk of disengagement of pipe threads and coupling threads during significant tensioning and bending.
4. The tightness is ensured by the pressure of the thread-sealing grease in the structural clearances of the threaded joint profile. At the request of the customer, it is allowed to make a threaded joint with a fluoroplastic seal ring in the coupling.
5. Quality control of mechanised make-up is carried out by the position of the coupling end relative to the triangular mark on the pipe. The joint is considered to be properly assembled when the coupling end does not reach the base of the triangular mark by one turn.

## Technical features

API 5CT				
Grade	Yield strength, ksi		Tensile strength, ksi (not less)	Percentage elongation, % (not less)
	min.	max.		
J55	54.97	80.06	74.98	*
K55	54.97	80.06	95	*
M55	64.98	84.99	84.99	*
L80 type 1	80.06	95	95	*
N80 type 1	80.06	109.9	99.93	*
N80 type Q	80.06	109.9	99.93	*
C95	95	109.9	105	*
P110	109.9	140	125	*

\* - value depends on the sample geometry

GOST 632-80				
GOST 632-80 strength group	Yield strength, ksi		Tensile strength, ksi (not less)	Percentage elongation, % (not less)
	min.	max.		
D	54.97	80.06	95	14.3
E	80.06	109.9	99.93	13.0
L	95	125	109.9	12.3
M	109.9	140	125	10.8



Winner of the competition  
"100 Best Goods of Russia"



Contest diploma winner  
"100 Best Products of the  
Republic of Tatarstan"



# EXTREME-LINE CASING PIPE N-S.\*BM FLUSH-JOINT HIGH-HERMETIC

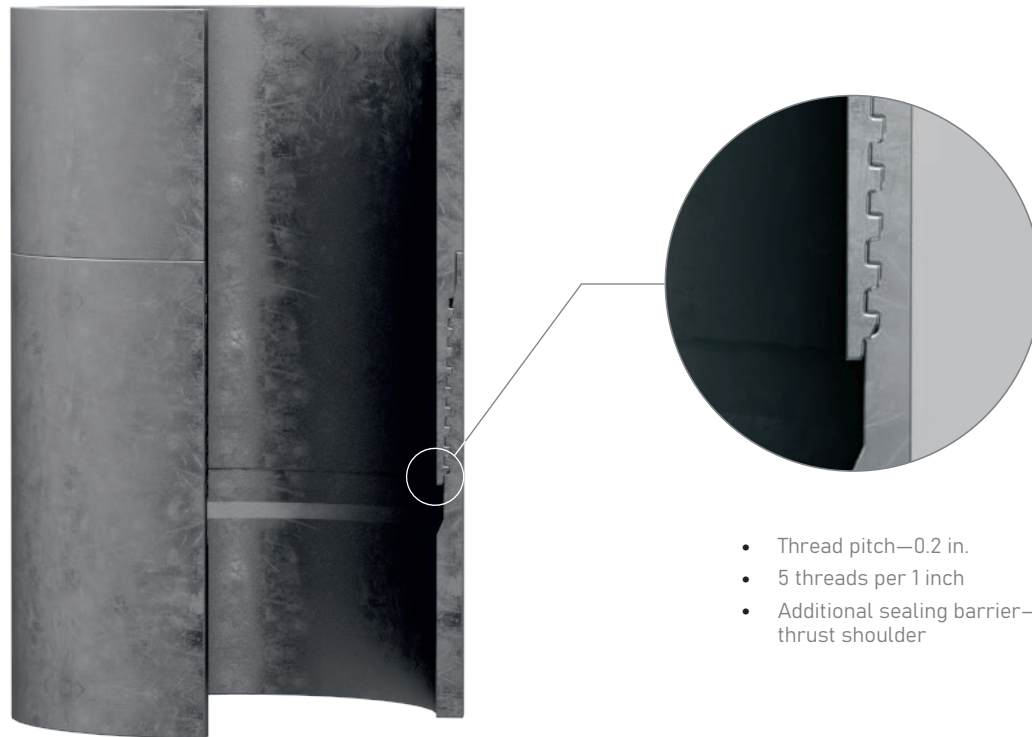

- Thread pitch—0.2 in.
- 5 threads per 1 inch
- Additional sealing barrier—thrust shoulder

## Purpose

Casing pipes are used for borehole wall lining after drilling, overlapping and isolating oil-, gas- and water-bearing formations and interlayers from each other.

## Field of application

The N-D.\*BM threaded connection has flush-joint of inside and outside pipe diameters, which allows reducing the string diameter and therefore its weight due to the reduction of the final borehole diameter, a rational combination of casing string and bore bit diameters.

To improve performance characteristics, the threaded joint uses additional tapered surfaces that on interference fit create a metal-to-metal seal, which provides a high tightness.

When making up the connection, the thrust ends of the pin and flared pipe ends come into contact with each other, creating high contact pressures on the thrust surfaces, which further contributes to the tightness of the connection.

## Advantages of a streamlined threaded joint

- High tightness of the joint and higher tensile strength compared to the triangular profile thread.
- Low cost of the pipe string due to the absence of couplings.
- Flush joint.
- Additional sealing barrier.

\*rated pipe diameter

### Technical features

Regulatory document	Pipe sizes			Strength group	Type of threaded joint
	Rated diameter, in	Nominal diameter, in.	Wall thickness, in.		
TU 24.20.12-008-37072885-2019 Seamless steel casing extreme-line pipes with threaded joint N-S.BM	4.02	4	0.23 0.26	D, K, E, L, M	N-S.102BM
	4.49	4.5	0.27 0.34		N-S.114BM
	4.72	4.75	0.27 0.31		N-S.120BM
	5.51	5.5	0.27 0.30		N-S.140BM



Winner of the competition  
"100 Best Goods of Russia"



Contest diploma winner  
"100 Best Products of the  
Republic of Tatarstan"



## Purpose

The couplings are intended to connect casing pipes used in construction of oil and gas wells and are manufactured as per GOST 632-80 with OTTM and OTTG threads, as well as BUTTRESS threads as per TU 14-ZR-29-2007.

Premium class casing pipe couplings with patented thread TMC-OTV, TMC1-SRV, TMC1-SRV2 are used in complex-profile oil and gas wells, requiring enhanced performance, as well as for extraction of super-viscous oil by steam-assisted gravity drainage.

## Field of application

- High-strength, high-hermetic threaded joint TMC-OTV is used in oil and gas wells of complex profile, as well as wells where coolant is transported at temperatures up to 482 °F. The unique design consists in sealing of the threaded joint due to interference contact at the pin toroidal seal band with the tapered bore in the box.
- High-strength, high-hermetic threaded joint TMC1-SRV provides high make-up torque (up to 20.283 lbf-ft), maintaining tightness under the action of combined tensile loads (up to 379.9 kipf), compression (at least 80%) and internal hydraulic pressure (up to 5.076 ksi) due to mating the threaded profile and two thrust elements "metal-to-metal".

- The high-strength, high-hermetic threaded joint TMC1-SRV2 is characterized by high compression, tension and bending capacity and meets the requirements level of CAL IV (the highest level of connection application) of GOST R ISO 13679-2016 (analogue of ISO 13679:2002 Petroleum And Natural Gas Industries-procedures For Testing Casing And Tubing Connection), which confirms the possibility of its use in the most difficult conditions of oil production. Furthermore, a feature of the TMC1-SRV2 threaded connection is that it can be assembled on an inclined rig mast.

## Advantages

- Production of couplings with premium threads of in-house design.
- Production of couplings according to specific requirements of the customer.

Premium TMC joints as per TU 1327-009-20970456-2015, TU 13 0814-100-78691656-2015

Type of threaded joint	Pipe schedule, D—t, in.	Strength group as per GOST 632-80 / API 5CT	Thread pitch, in.
TMC Premium joints			
TMC-OTV- 6,35-245	9.65-0.35; 9.65-0.39	D, E, L, M	0.25
TMC1-SRV	6.61-0.35	D (A) / J55	0.2
TMC1-SRV2	9.65-0.35	E / N80	0.25

### Technical features

#### GOST 632-80

Nominal pipe diameter, in.	Outside diameter, in.	Length, in.	Weight, lb	Thread pitch, in.	Strength groups
4.02	4.33	7.48	7.28	0.2	as per GOST 632-80
4.5	5	6.69	8.82	0.2	
5	5.5	6.85	10.58	0.2	
5.75	6.54	7.17	17.42	0.2	
6.61	7.39	7.48	20.94	0.2	
7.01	7.66	7.79	18.96	0.2	
9.65	10.63	8.58	43.87	0.2	



## Purpose

The company performs diagnosis and overhaul of drill pipes using a unique technology of metal build-up on the surface of interlocking parts.

## In the process of overhauling

of the drill pipes the following operations are carried out:

- mechanical cleaning of the outer and inner surfaces of the pipe;
- diagnostics of smooth pipe wall thickness by ultrasonic flaw detection;
- determination of the geometric parameters of the surfaces of the interlocking and threaded parts;
- straightening of pipes in order to restore straightness;
- metal build-up welding on the surface of the locks with their extension along the pipe body using a unique patented technology;
- machining of the build-up surfaces of locks until their dimensions are fully restored;
- re-cutting of threaded parts on state-of-the-art CNC machines.

## Advantages

- The main advantage of the proposed technology is the restoration of the interlocking part of the onworn pipe to the condition of a new pipe. The built-up metal is precisely matched in its properties to the quality of the pipe interlock metal, as a result of which the wear resistance of the restored surfaces is not inferior to the new pipes, and machining of the built-up surfaces is carried out until a full recovery of the geometric dimensions as per GOST 28487.
- The entire technology for building-up the interlock parts is realized on specially designed equipment installed in the process train has the appropriate certificates and permissions for application.



### Range and schedule-sizes of drill pipes to be repaired and basic dimensions

Schedule-size		Thread	External thread diameter as per GOST 50278-92, in.	Outside upset diameter as per GOST 50278-92, in.	Lock outside diameter after repair as per GOST 27834-95	Pipe wall thickness, in.			Length of the cylindrical part after repair, in. not less	
pipes	lock					as per GOST 27834-95	repaired, not less than		pin	box
	GOST 27834-95						1st class	2nd class		
PV-73x9	ZP-95-32	Z-73	2.87	3	3.75	0.36	0.29	0.23	5.58	6.59
PN-73x9	ZP-105-54	Z-86	2.87	3.19	4.13	0.36	0.29	0.23	5.58	7.13
PV-89x9	ZP-108-44	Z-86	3.5	3.63	4.2	0.37	0.29	0.23	5.58	7.13
PV-89x11	ZP-108-41	Z-86	3.5	3.63	4.2	0.45	0.35	0.28	5.58	7.13
PN-89x9	ZP-121-68	Z-102	3.5	3.87	4.75	0.37	0.29	0.23	5.58	7.63
PN-89x11	ZP-127-65	Z-102	3.5	3.87	5	0.45	0.35	0.28	5.58	7.63
PK-114x9	ZP-159-83	Z-132	4.5	4.69	6.25	0.34	0.27	0.21	5.58	8.49
PK-114x11	ZP-159-76	Z-122	4.5	4.69	6.25	0.43	0.34	0.27	6.34	8.49
PK-114x9	ZP-162-95-1	Z-133	4.5	5	6.37	0.34	0.27	0.21	6.28	8.49
PK-114x11	ZP-162-92	Z-133	4.5	5	6.37	0.43	0.34	0.27	6.34	8.49
PK-127x9	ZP-162-95-2	Z-133	5	5.1	6.37	0.5	0.4	0.31	6.22	8.49
PK-127x13	ZP-162-89-2	Z-133	5	5.1	6.37	0.5	0.4	0.31	6.5	8.49
PN-127x9	ZP-178-102	Z-147	5	5.69	7	0.36	0.29	0.31	6.84	9.02
PN-127x13	ZP-178-102	Z-147	5	5.69	7	0.5	0.4	0.31	6.84	9.02

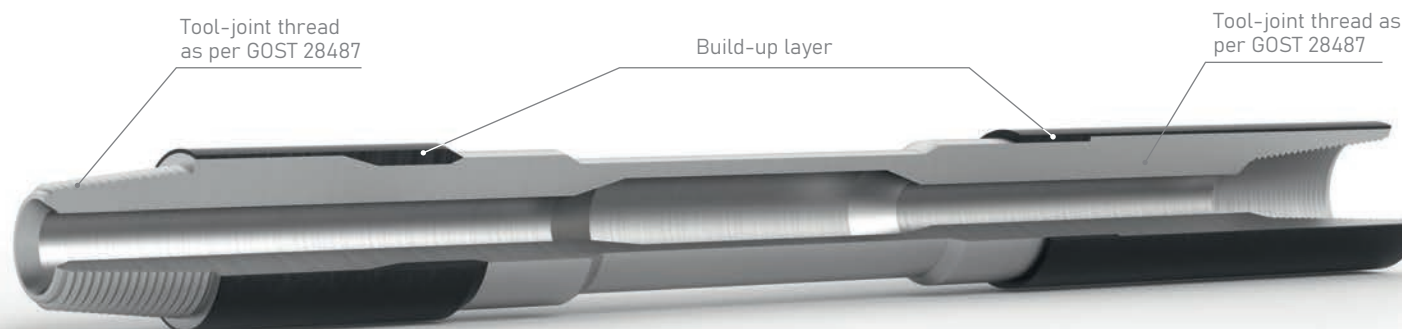

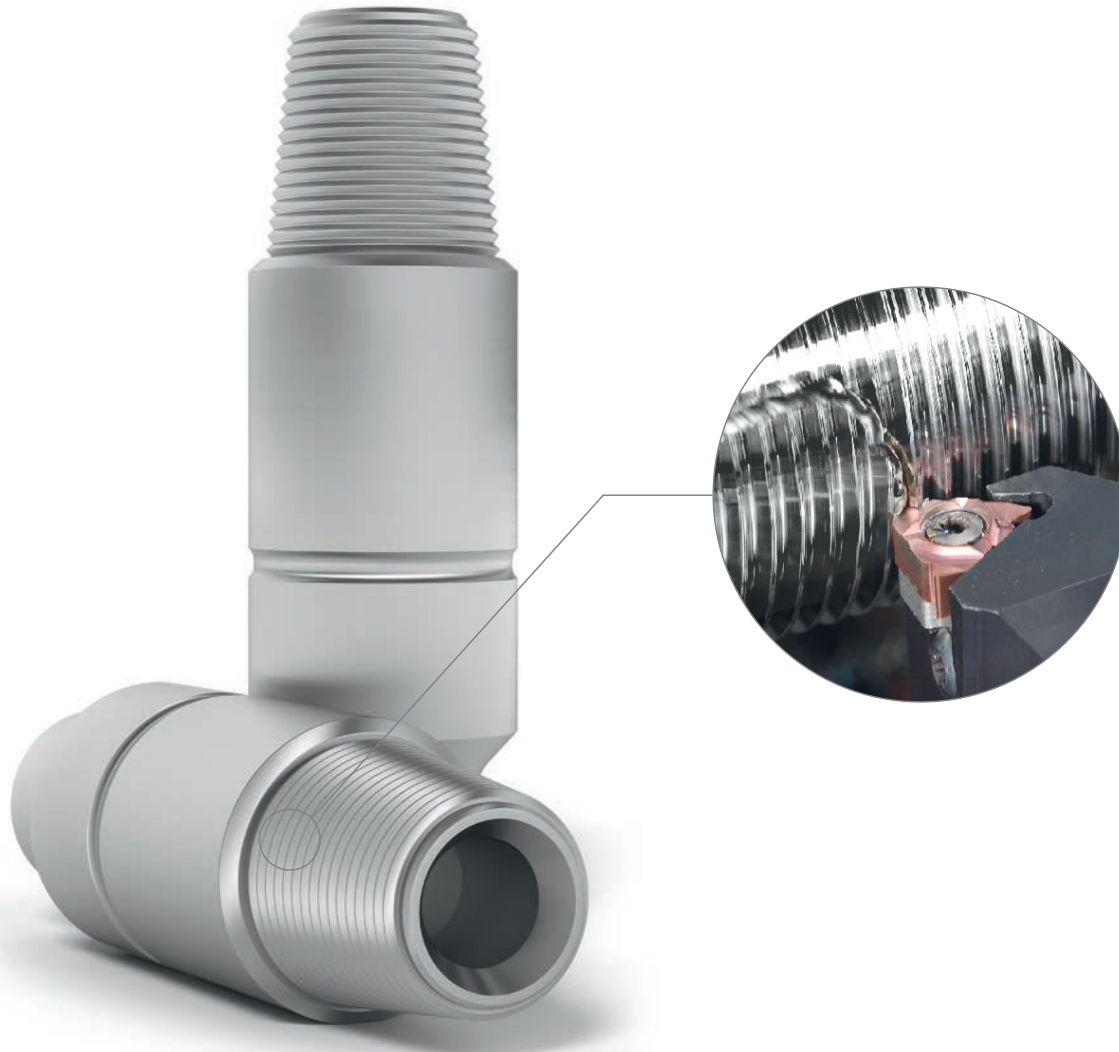

TMC Group Managing Company LLC manufactures box and pin subs for drill strings as per GOST 23979-80 and non-standard reducers according to the customer technical requirements

### Technical features

Connecting thread	Tool-joint as per GOST 7915-75
	Tubing as per GOST 633-80
	Casing, OTTM as per GOST 632-80
Tensile strength, ksi	over 127.9
Yield strength, ksi	over 106.6
Percentage elongation, %	over 10
Percentage reduction, %	over 45
Impact toughness, J/m <sup>2</sup>	over 685x10 <sup>3</sup>
Brinell hardness	HB 285...341

# FLASH WELD TOOL JOINTS



The company manufactures and sells GOST 27834 weld tool joints for drill pipes as per GOST R 50278 and also manufactures weld tool joints with threaded connections for drill pipes produced by HILONG Solution.

High-alloy steels of domestic production, heat treated and with improved mechanical properties of steels are used for manufacturing weld tool joints.

The threaded profiles of tool joints are subjected to the process operation of “cold galvanizing” to reduce the coefficient of friction and heat between the tool-joint threads, and eliminate the effect of “cold welding” and thread pitting when make-up and breakout during the operation of drill pipe.

### Advantages

- Coating of threaded parts of the tool joint—cold galvanized.
- Quality control of metal and threaded parts of the tool joint: ultrasonic flaw detection (UT)—control, magnetic particle inspection of the thread profile of tool joints (MPI)—control.



### Technical features

Tool joint steel	30KhGSA steel
Hardness of the tool joint body	HB 300...335
Length of the tool joint pin, in.	11.81
Length of the tool joint box, in.	12.99
Diameter of welded tool joint, in.	5.32 to upsetting of the pipe body
Tool joint outside diameter, in.	6.38
Tool joint inside diameter	3.74
Wrench length of the tool joint box, in.	10.04
Wrench length of the tool joint pin, in.	7.09
Tool-joint thread	HL 50 (Z-133)
Tensile strength of the tool joint metal, ksi	142.3
Yield strength of tool joint metal, ksi, not less	120.7

# TYPES OF REPAIRABLE THREADED JOINTS



TMC Group Managing Company LLC is the only center in the European part of the Russian Federation accredited by the manufacturer Shanghai Hilong for cutting of the patented double-shouldered threaded tool joint HLIDS.

### The company makes

1. Shanghai Hilong Drill Pipe Repair.
2. Drill pipe subs with HLIDS 31, 38, 50 joints.

Joints as per GOST 28487-2018



Joints as per API Spec 7-2

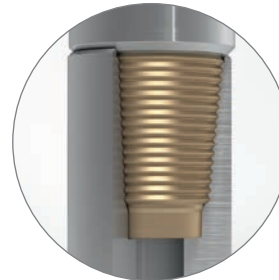

Z-108, Z-117, Z-121, Z-152, Z-171, Z-177, Z-178  
tool joint cutting is performed as well



### Technical features

Nominal tube diameter, mm (in.)	Type of tool joint	Thread type
Joints as per GOST 28487-2018		
73 (2.87)	ZP-95-32	Z-73
73 (2.87)	ZP-105-44	Z-86
89 (3.50)	ZP-108-44	Z-86
89 (3.50)	ZP-108-41	Z-86
89 (3.50)	ZP-121-68	Z-102
89 (3.50)	ZP-127-65	Z-102
114 (4.49)	ZP-159-83	Z-122
114 (4.49)	ZP-159-76	Z-122
114 (4.49)	ZP-162-95	Z-133
114 (4.49)	ZP-162-92	Z-133
127 (5.00)	ZP-162-95	Z-133
127 (5.00)	ZP-162-89	Z-133
127 (5.00)	ZP-178-102	Z-147
127 (5.00)	ZP-178-102	Z-147
Joints as per API Spec 7-2 (including Shanghai Hilong tool joints)		
3.5	ZP-105-51	HLIDS 31
4	ZP-127-65	HLIDS 38
5	ZP-168-89	HLIDS 50
2.8	as per API 5DP	NC31
3.5	as per API 5DP	NC38
4.5; 5.0	as per API 5DP	NC50



### Purpose

The device is intended to reliably secure and prevent axial movement of the casing hardware on the casing body.

### Field of application

The device is used in vertical, directional sidetracks or wellbores with a horizontal ending.



### Technical description

The locking ring consists of:

**Collets**, a split sleeve with lobes that have the ability to deflect inward. There are teeth on the outer surface of lobes, which form a strong engagement with the teeth of the ring;

**Rings**, made of special hardened steel, with a conical surface on the inside, as well as teeth that form a strong meshing with collet teeth.

Mounting of the device is organized on the drilling rig catwalk. The collet and the ring are installed on the casing pipe. The ring is put on the collet with a certain force until the teeth are fixed. Under the action of the ring tapered surface the collet lobes get compressed, thereby ensuring a secure hold.

The ring is fitted to the collet using a special hydraulic device (wrench), allowing the even fitting of the ring with the required and sufficient torque.

### Advantages

- Simple design and installation.
- The shear force of this device is 1.2 times higher than recommended by international standard ISO 10427-2:2004.
- Secure hardware fixation to the casing body, ensuring that it reaches its design depth.

### Technical features

Schedule-size	Drift diameter, in.	Outside diameter, in.	Length, in.	Set installation time, min., NOV	Installation/ stripping force, kipf	Weight, lb
114	4.57	5.08	2.95	3	up to 6.74/ up to 9.44	2.65



# STRING SHOE WITH BKPOK CHECK VALVE AS PER TU 28.99.39.190-089-78682242-2019



## Purpose

String shoe with BKPOK check valve (TU 28.99.39.190-089-78682242-2019) is intended to equip the casing string bottom and protect it from damage while running-in.

A special design feature is the use of a special plastic nozzle, lightening the structure and having a number of structural advantages over the traditionally used cement stone.

## Field of application

In oil and gas wells as part of the process equipment of casing with TMC-SRV2 premium threaded connection elements.

## Advantages

- Equipped with a check valve that prevents drill mud from flowing into the casing string in the course of its running-in and prevents the grouting mortar circulation from the bottom upwards. The maximum pressure drop is up to 3.626 ksi.
- It has a lightweight structure, not inferior to analogues in strength characteristics.
- All shoe inner parts are made of easy-to-drill materials, which allows minimizing the costs of further work.
- Any type of threads of joined surfaces—at customer's option.

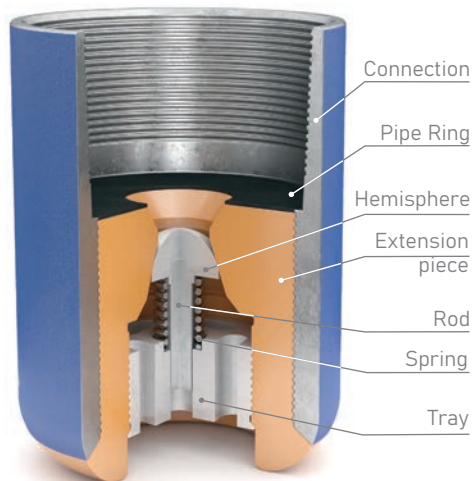

## Technical features

Name	Nominal sting diameter, in.	Type of connecting thread	Outside diameter D, NOV, in.	Inside diameter d, NLT, in.	Diameter D1, NLT, in.	Height H, in.	Weight, lb, NOV
BKPOK-114 SRV	4.49	TMC1-SRV2	5.24	1.58	2.36	10.63	19.84
BKPOK-146 SRV	5.75	TMC1-SRV2	6.54	1.58	3.15	12.6	39.68
BKPOK-168 SRV	6.61	TMC1-SRV2	7.40	2.36	3.94	14.17	50.71
BKPOK-178 SRV	7.01	TMC1-SRV2	7.68	2.36	4.53	14.96	66.14
BKPOK-245 SRV	9.65	TMC1-SRV2	10.63	2.36	5.9	14.57	112.4

# STRING SHOE OF BK-P AND BKM TYPE



## Purpose

The shoe is designed to equip the casing string bottoms in order to guide them along the wellbore and protect them from damage while running-in in the course of lining the oil and gas wells with the temperature at the bottom of up to 482 °F.

## Field of application

In oil and gas wells as part of the process equipment of casing strings with connecting elements made with any threads, including premium.

## Advantages

- The shoe consists of a rugged steel body and a hemispherical concrete extension connected thereto.
- The product is easy to drill.
- Can be made with connecting short triangular thread, with trapezoidal threads OTTM and OTTG as per GOST 632-80.
- Can be made with TENARIS and BUTTRESS threads according to American Petroleum Institute (API) standards and TU 3663-004-78682242-2014 specifications.

## Technical features of the BK-P string shoe

Shoe type	Nominal casing string nominal diameter, mm (in.)	Outside diameter of the device, d, in.	Device drift diameter, d, in.	Tip central hole diameter, d1, in.	Side outlet diameter, d2, in./ n number	Device length, L, in.	Connecting thread GOST 632-80	Weight, lb
BK-P 146	146 (5.75)	6.54	5.43	2.76	0.59/6	11.69	OTTM146	28
BK-P 168	168 (6.61)	7.39	6.3	3.15	0.59/6	12.52	OTTM168	34.17
BK-P 178	178 (7.01)	7.64	6.69	3.54	0.71/6	12.76	OTTM178	54.45
BK-P 245	245 (9.65)	10.63	9.29	4.72	0.79/6	13.86	OTTM245	66.58
BK-P 324	324 (12.76)	13.82	12.4	6.3	0.79/6	15.63	OTTM324	106.5

## Technical features of the BKM string shoe

Type, shoe symbol	Nominal diameter, in.	Outside di-iameter D, in.	Central hole diameter D1, in.	Height H, in.	Weight, lb, NOV
BKM-114	4.49	5.12	1.97+0.39	10.63	33.07
BKM-146	5.75	6.54	2.76+0.39	11.69	39.68
BKM-168	6.61	7.40	3.15+0.39	11.81	52.91
BKM-178	7.01	7.79	3.54+0.39	12.8	70.55
BKM-245	9.65	10.63	4.72+0.39	14.76	121.3
BKM-324	12.76	13.82	6.30+10	14.17...15.35	191.8
BKM-426	16.77	17.76	8.66+0.39	16.54	330.7

# STRING SHOE WITH BKO CHECK VALVE

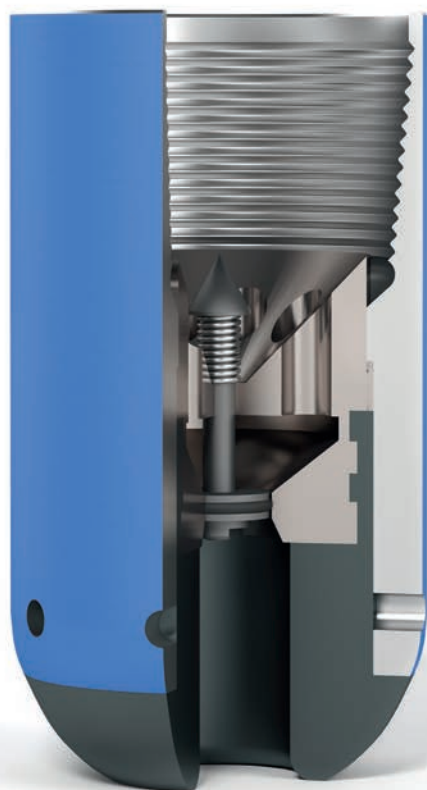

## Purpose

It is intended to equip the bottom of the casing string made of pipes as per GOST 632-80 in order to guide them along the wellbore and protect against damage when running into the well, as well as to prevent grouting mortar backflow into the casing string after its forcing through.

## Field of application

In oil and gas wells as part of the process equipment of casing strings with connecting elements made with any threads, including premium.

## Advantages

- The shoe consists of a rugged steel body and a hemispherical concrete extension connected thereto.
- The product is easy to drill.
- Can be made with connecting short triangular thread, with trapezoidal threads OTTM and OTTG as per GOST 632-80.
- Can be made with TENARIS and BUTTRESS threads according to American Petroleum Institute (API) standards and TU 3663-004-78682242-2014 specifications.

## Technical features

Shoe type and thread type	String nominal diameter, mm (in.)	Product designation	Outsider diameter D, in.	Central hole diameter D, in.	Height H, in.	Weight, lb
BKO-114	114 (4.49)	UNBR 069.00.000	5.24	2.05	10.79	24.25
BKO-127	127 (5.00)	UNBR 068.00.000	5.75	2.36	11.02	29.1
BKO-140	140 (5.51)	UNBR 066.00.000	6.26	2.76	12.4	38.36
BKO-146	146 (5.75)	UNBR 061.00.000	6.54	2.76	12.52	42.33
BKO-168	168 (6.61)	UNBR 071.00.000	7.40	3.15	14.17	61.07
BKO-178	178 (7.01)	UNBR 070.00.000	7.79	3.54	14.96	70.99
BKO-194	194 (7.64)	UNBR 071.00.000	8.50	3.54	15.94	80.03
BKO-219	219 (8.62)	UNBR 072.00.000	9.65	4.72	16.54	107.8
BKO-245	245 (9.65)	UNBR 073.00.000	10.63	4.72	16.93	143.3
BKO-273	273 (10.75)	UNBR 074.00.000	11.77	4.72	16.34	154.3
BKO-299	299 (11.77)	UNBR 075.00.000	12.76	4.72	15.94	167.1
BKO-324	324 (12.76)	UNBR 076.00.000	13.82	6.3	15.94	202.8
BKO-340	340 (13.39)	UNBR 077.00.000	14.37	6.3	16.34	214.7

# REPAIR OF HYDRAULIC AND PNEUMATIC TONGS

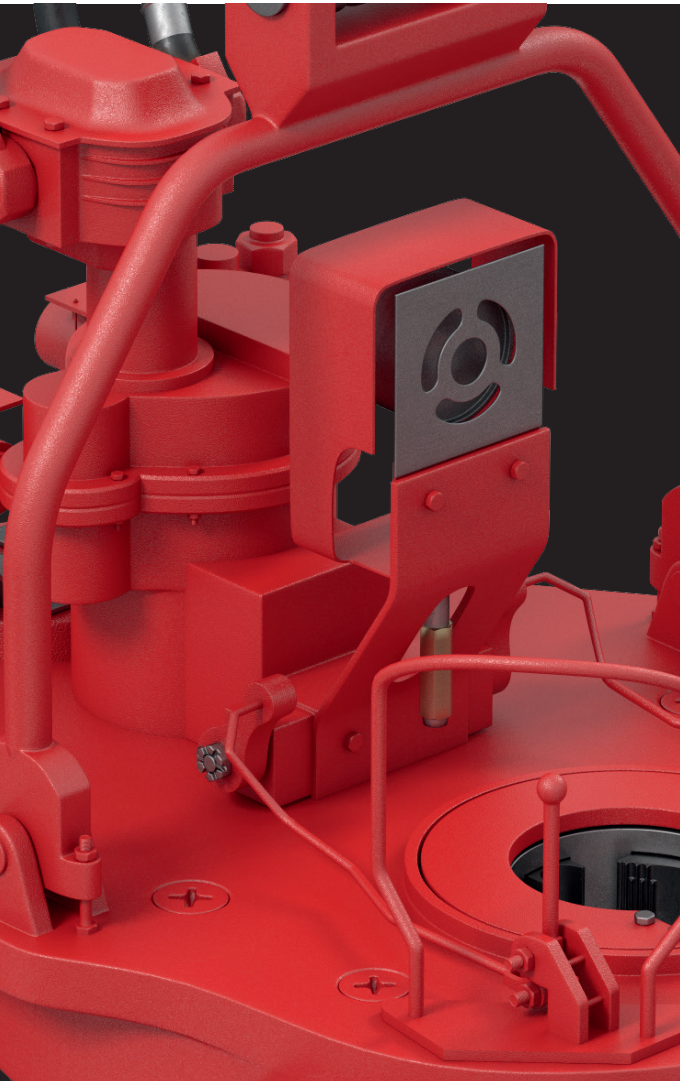

## Purpose

The AKB-3, AKB-4 tongs are intended to make-up and breakout drill pipes and casing pipes during round-trip operations when drilling oil and gas wells.

Hydraulic tongs GKSh-4000, GKSh-1500, GKSh-3200 are used for underground and overhaul repair of wells and are intended for quick, safe, and accurate making up and breakout of drill pipes and tubing strings.

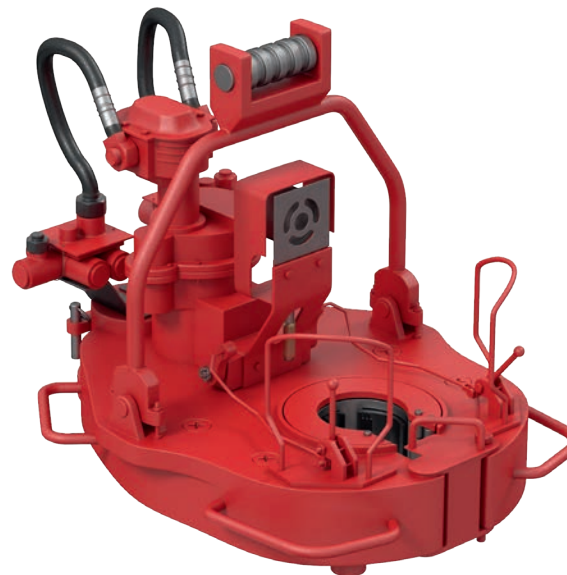

## Tongs repair technology:

- manufacturing of tongs component parts and assemblies;
- restoration of parts by build-up welding;
- bench-testing.

The company repairs drilling tongs of both domestic and foreign manufacture.







The company performs repair and overhaul of domestic and imported drilling equipment and pumps.

The repair of drilling equipment involves the following repair and recovery techniques:

- reconditioning of body parts, shafts by build-up welding;
- manufacture of new parts, including repair dimensions;
- heat treatment and surface hardening;
- restoration by polymeric coating of working surfaces;
- manufacture of fabricated rubber products;
- manufacture of metalware;
- trial run and hydraulic tests on special-purpose test benches.

In order to reduce the time for repairs, a warehouse of spare parts for drilling equipment has been organized at the premises of TMC Group Managing Company LLC; the logistics of spare part supplies has been arranged, cooperation with machine tool builders and repair bases of the Volga Region and the Urals has been established.

We perform the overhaul the following types of drilling equipment and drilling pumps:

- Russia (Volgograd plant of drilling equipment: BU-75, BU 1600/100, BU-2000/125E, BU-2000/125EBM, BU-2500, BU-2900, BRN-1, NBT-600; Uralmash: UNB-600, NBT-950; Izhdril: 8T-650; KMZ: A60/80);
- USA, Canada (Dreco, Kremco, Ideco, Cardwell, IRI, Cabot, Gardner Denver, Brandt);
- China (Honghua, SLS).





### Repairable equipment:

- swivels;
- lifting and transmission shafts of drilling rigs;
- chain reducing gear, bevel gear speed reducers, gearboxes;
- rocker-machine gearboxes;
- crown blocks, traveling blocks;
- hooks, hook-blocks;
- vibrating screens;
- rotors R-560, R-700, R-410;
- hydraulic brakes;
- crankshafts and transmission shafts of drilling pumps;
- hydraulic boxes of drilling pumps BRN-1, UNB-600, 8T-650 etc.;
- top drive systems.

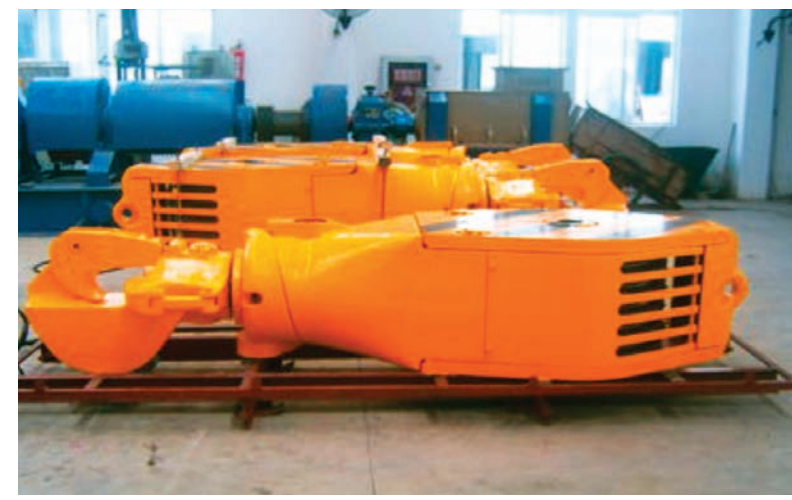

# REPAIR, MAINTENANCE AND TESTING OF BLOWOUT PREVENTION EQUIPMENT



## Purpose

Blowout prevention equipment is intended to seal wellheads in order to prevent blowouts and spouters.

## Preventer repair technology:

- overhaul of preventers with complete stripping, reconditioning of parts, and reassembly of the product;
- restoration of preventer bodies by build-up welding;
- Main State Expertise of the industrial safety of preventer parts with the issuance of a report on the state of operability;
- bench-testing for working and test pressure.

## Technical features

Modification of BPE	Operating pressure, ksi	Test pressure, ksi	Diameter of the through hole, in.	Number of revolutions of each hand wheel required for shutting	Flange outside diameter	Weight, lb
PP-230x35	5.076	10.15	9.05	-	18.11	2.116
PPShR-2FT-152x21	3.046	6.092	5.98	14-17	-	1.102
PMT-156x21	3.046	6.092	6.1	14-15	14.96	617.3
PPO-152x21	3.046	6.092	5.98	14-16	15.55	529.1

A large, stylized illustration of pipeline components in white and teal. It includes a vertical pipe section with a threaded top, a smaller pipe section with a flange, and a horizontal pipe section with a flange. The background is a teal gradient with circular cutouts showing industrial scenes.

# PIPELINE PRODUCTS

## PIPELINE PRODUCTS

87 METAL-PLASTIC PIPES AND PUP-JOINTS

88 METAL-SPRAYED COATING OF END SECTIONS OF PIPES AND PIPELINE PARTS WITH AN INTERNAL CORROSION-RESISTANT COATING (MPK) PROTECTIVE SLEEVE MADE OF CORROSION-RESISTANT STEEL (FLUSH-JOINT), INSTALLED IN THE FACTORY IN THE AREA OF UNINSULATED PIPE / PART SECTION

89 STEEL PIPES Ø 2.24-32.28 IN. WITH OUTER TWO- AND THREE-LAYER POLYETHYLENE COATING

90 INTERNAL AND EXTERNAL CORROSION-RESISTANT COATING OF PIPELINE PARTS AND ASSEMBLIES

92 PIPES, HEAT-INSULATED WITH POLYURETHANE FOAM FOR UNDERGROUND AND ABOVE-GROUND ROUTING

93 TYPES OF HEAT-INSULATED PIPES

94 SHAPED PARTS OF PIPELINES WITH HEAT-INSULATION OF POLYURETHANE FOAM

95 TUBING, CASING, AND LINE PIPES OF STEEL WITH INTERNAL CORROSION-RESISTANT COATING

96 SLEEVE TPS-TK  
Spec.

98 POLYETHYLENE PIPES FOR INDUSTRIAL APPLICATIONS FOR SERVICE AND DRINKING WATER SUPPLY FOR GAS PIPELINES

99 EXTERNAL CORROSION-RESISTANT COATING OF STEEL PIPES BASED ON POWDER MATERIALS

100 MEST™ MECHANICAL ELECTRICALLY INSULATING CONNECTION OF PIPELINES

102 POLYETHYLENE FILM



# METAL-PLASTIC PIPES AND PUP-JOINTS (TU 24.20.13-026-67740692-2018, TU 24.20.13-115-78682242-2022)

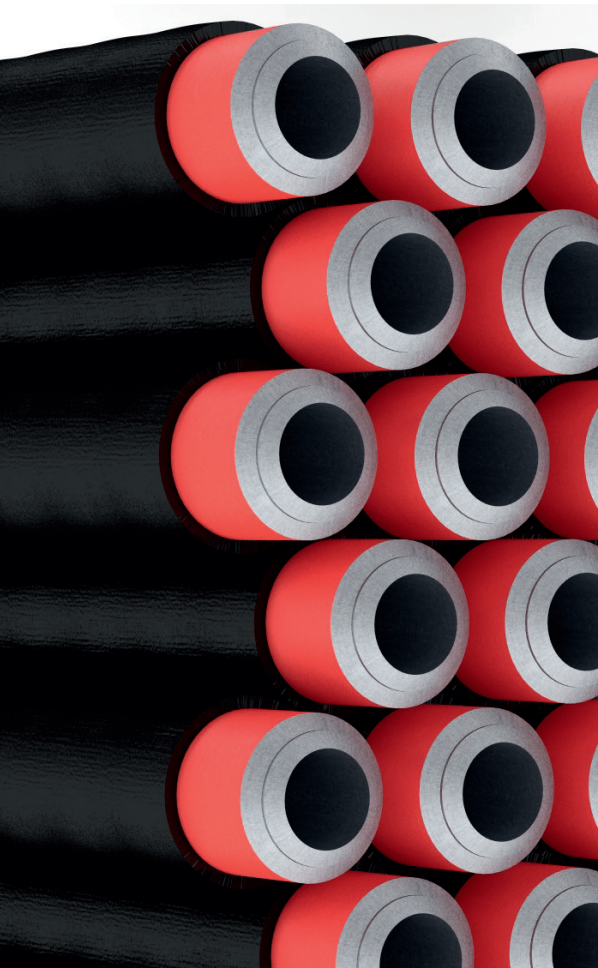

**Metal-plastic pipes and pup-joints with diameter up to 12.8 in. with maximum wall thickness of 0.87 in. represent a steel pipe, a pup-joint pipe with polyethylene (for underground routing) or paint coating (above-ground routing), lined with polyethylene pipe (shell) on the inside and fixed with tips made of:**

- structural carbon steel (MPT—metal-plastic pipes);
- corrosion-resistant steel (MPTK—metal-plastic corrosion resistant pipes).

**MPT, MPTK and MPTK (1) can be made in two versions:**

- Normal—operating temperature up to +104 °F.
- Heat-resistant—operating temperature above +104 °F, but NOV +176 °F.

## **Purpose**

MPT, MPTK and MPTK (1) are designed for the construction of pipelines transporting:

- oil-field water, refinery water, and fresh water in the reservoir pressure maintenance system;
- corrosive environments of the chemical, petrochemical, oil-refining industries to which polyethylene is chemically resistant.

## **Advantages**

The structural reliability is ensured by:

- Effective protection of the inner surface of steel pipes from aggressive effects of the transported medium.

- Effective protection of the outer surface of steel pipes from the effects of soil corrosion by polymer, powder or paint coating.
- Protection of the welded joint area with a corrosion-resistant tip.
- Structural durability—service life of at least 30 years.
- No change in the pipeline throughput over the years of operation due to the absence of buildups.

## **Products are supplied complete with pipeline parts**

- Bent branches from 5° to 120° with a ratio of 1° and diameter of up to 6.26 in.
- Bent branches with weldnecks from 3.5 to 12.8 in. in diameter.
- Crossovers and T-bends from 3.5 to 12.8 in.
- S- and L-shaped bends up to 6.26 in.

## **Reliability is ensured by**

- Observation of the welding conditions in the field. The company provides author's supervision and engineering support for the first 1.864-3.107 mi of pipeline with training for the construction crew.
- Additional visual supervision of the welding process by changing the color of the thermal indicator material applied to the length of the uninsulated section at the request of the customer.



# METAL-SPRAYED COATING OF END SECTIONS OF PIPES AND PIPELINE PARTS WITH AN INTERNAL CORROSION-RESISTANT COATING (MPK) PROTECTIVE SLEEVE MADE OF CORROSION-RESISTANT STEEL (FLUSH-JOINT), INSTALLED IN THE FACTORY IN THE AREA OF UNINSULATED PIPE / PART SECTION



## Purpose

Metal-sprayed coating (MPK), used to protect the end sections of pipes/parts with a press-fitted sleeve, is designed for corrosion protection of the inner surface of the welded seam and the heat-affected zone.

## Advantages

### Technological effectiveness

The inner pipe diameter is unchanged, which allows to:

- use mechanical aids for pipeline cleaning (scrapers);
- avoid creation of additional local resistance to fluid flow in the place where the sleeves are installed.

It is installed in the factory in compliance with all technical parameters.

### Minimizing labor costs

- Up to 46% cheaper than installing conventional sleeves in the field.
- Prevents the ingress of highly corrosive components of the environment to the metal of the welded joint.

## Manufacturer's warranties

Service life of pipes with internal paintwork coating and additional metal spraying of pipe ends / parts is at least 15 years

## Technical features

Name	Values
Tube diameter, in.	3.50-12.8
Operating pressure, ksi	4.35
Operating temperature, °F	-40... +302

## Reliability

- The fixed sleeve mounting force and the sealant used ensure high insulation reliability in the heat-affected zone.
- High barrier properties of the weld protection system.

## Field of application

In industrial pipelines transporting corrosive liquids.



Pipes



Pipeline parts



Pipe sections

## Reasons to choose our products

1. We will select the type of internal corrosion protection of pipes depending on the operating conditions.
2. Examination of the welded joint structure of pipes and sleeves showed the absence of corrosion damage in the course of field tests.

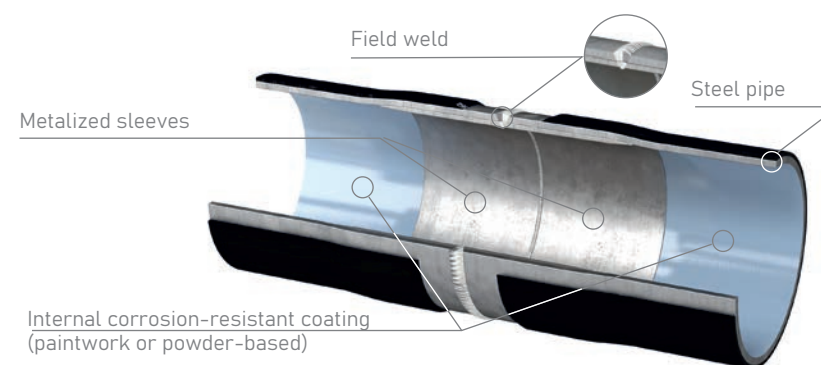

Winner of the competition "100 Best Goods of Russia"



Contest diploma winner "100 Best Products of the Republic of Tatarstan"

# STEEL PIPES Ø 2.24-32.28 IN. WITH OUTER TWO- AND THREE-LAYER POLYETHYLENE COATING (TU 1390-001-67740692-2010, TU 24.20.13-117-78682242-2022)



## Purpose

For reliable and durable corrosion protection of the outer surface of steel pipes, pipe sections, insulated in the factory:

- two-layer outer protective coating based on extruded normal and reinforced polyethylene of Ø 2.24-32.28 in.;
- three-layer outer protective coating based on extruded normal, reinforced, heat-resistant, and special-purpose polyethylene of Ø 3.50-32.28 in.



Diploma winner of the contest «100 best goods of the Republic of Tatarstan»

## Field of application

It is used in construction of main and field gas pipelines, oil and water pipelines, as well as in the construction of engineering networks (water conducts, sewage).

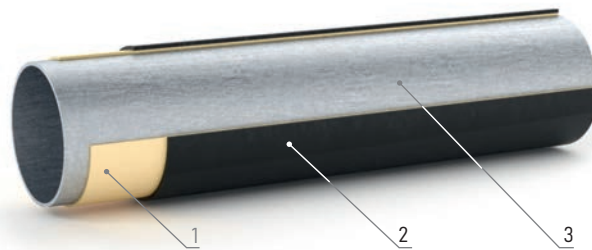

## Pipe with outer two-layer polyethylene coating:

- 1) polyethylene layer;
- 2) adhesion layer;
- 3) steel pipe.

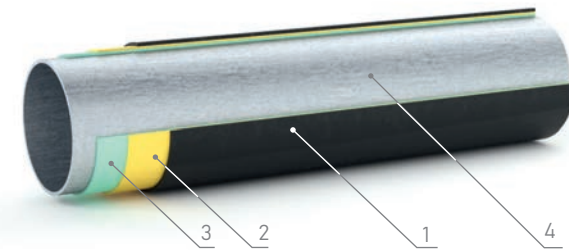

## Pipe with outer three-layer polyethylene coating:

- 1) polyethylene layer;
- 2) adhesion layer;
- 3) primer layer;
- 4) steel pipe.

## Advantages

- Compared to traditional bitumen-mastic and polymer tape coatings, the factory polyethylene pipe coating has a high impact strength, enhanced adhesion to steel, resistance to forcing through, puncture, abrasion, and abrasive wear. Due to high adhesion, it is resistant to shear loads arising from setting of ground and in the course of shifting of pipeline sections during operation.
- The quality of the external polyethylene coating of pipes and pipeline parts, as applied in our conditions, meets the requirements of GOST R 51164-98, GOST 9.602-2005, GOST 31448-2012. Products are certified.
- Three-layer polyethylene pipe coating structurally differs from the two-layer one by the presence of another layer, an epoxy primer. The epoxy layer provides an enhanced coating's adhesion to steel, water-resisting adhesion and resistance to cathodic disbonding. The polymer adhesion sublayer is the second, intermediate layer in the structure of the three-layer coating.
- Maximum operating temperature up to +176 °F.

# INTERNAL AND EXTERNAL CORROSION-RESISTANT COATING OF PIPELINE PARTS AND ASSEMBLIES

(TU 1468-020-67740692-2012, TU 24.20.40-121-78682242-2022)



The company sells pipeline assemblies and parts with internal and external protective corrosion-resistant coating based on paintwork and powder polymer compounds.

**Assemblies** are sections of a pipeline or other facility under construction consisting of combinations of assembly components: pipeline parts (tees, bent branches, crossings, bottoms, plugs, transition rings) and pup-joints.

**Pipeline parts** are connecting parts used in the construction of pipelines for various purposes. They are used for turns, bends, tilts, branches, changes in the diameter of the pipe, as well as in cases of temporary non-use of the pipeline.

### Purpose

Intended for capital construction and overhaul of process and field pipelines (oil and gas pipelines, low-pressure water conducts of above-ground, underground and underwater routing). The temperature of the transported medium is up to +302 °F.

### Diameter range

2.24 to 20.87 in.

### Advantages

- The labor intensity of manifold pipeline production is reduced by an average of 25%.
- Organizational losses are reduced.
- Waste and material loss are reduced.
- Material storage costs on-site are reduced.
- It is possible to supply fabricated assemblies according to the schedule, to the needs of the installation of a particular object.
- Piping assemblies are manufactured as per customer's drawings.
- Packed and delivered according to the scheme agreed with the customer:
  - in boxes;
  - on pallets;
  - in bulk.
- 100% visual inspection and radiographic tests of the welded joint.

### Coating features

The internal coating of parts, assemblies of pipelines is performed as:

- two-layer, consisting of a primer layer based on epoxy or epoxyphenolic primer and a coating layer based on epoxy powder paints;
- one-layer based on liquid epoxy, polyurethane paints.

Coating materials are selected based on the pipeline operating conditions and transported fluids.

### Coating Properties

- It is resistant to oil, fuels, industrial and waste water.
- It is resistant to the damaging effects of stray currents.
- High degree of coatings adherence to the steel surface (adhesion).
- High mechanical strength.

### Installation methods

- Pipeline assemblies and parts with internal protective corrosion-resistant coating are installed on site.
- Construction works performed under especially complex conditions are simplified to the maximum for pipe installers when pipeline manifolds are supplied as enlarged assemblies, allowing 50 to 70% of all welding operations to be done in the factory.
- the time of construction and erection works is reduced by an average of 25%.
- Material storage costs on-site are reduced.
- Preparation of the ends can be made for welding or flanged joint.

### Additional options

- At the customer's request for the purpose of protecting against external corrosion it can be combined with:
  - polymer coating based on powder materials;
  - polymer coating based on liquid materials;
  - polymer coating based on polyethylene or heatshrink materials.

- In order to protect the welded joint and the heat-affected zone, it can be combined with a metal-sprayed coating or a corrosion-resistant steel tip.

### End preparation options

- For welded joint complete with protective sleeves.
- For welded joint with mounted corrosion-resistant steel tips.
- For welded joint with the application of metal-sprayed coatings.
- For flanged joints.

Coating materials are selected based on the pipeline operating characteristics, and agreed with the designers of the pipeline and its customer.

The materials are characterized by chemical and thermal resistance, approved for use in appropriate environments and supported with laboratory test reports.

### Possibilities of shop fabrication of piping assemblies

- Transfer of up to 70% of all labor costs from the installation site to the workshop.
- Mechanization of majority of production operations.
- Use of high-performance machines and mechanisms, assembly and welding jigs.
- Semi-automatic welding methods.
- Implementation of new design solutions in manifold designing.

# PIPES, HEAT-INSULATED WITH POLYURETHANE FOAM FOR UNDERGROUND AND ABOVE-GROUND ROUTING



## Purpose

Foam polyurethane (hereinafter referred to as FPU) thermal insulation is designed to maintain the temperature of the pumped medium and protect the outer surface of steel pipes and shaped parts of pipelines against corrosion in combination with corrosion-resistant coatings.

## Field of application

- Heat supply systems.
- Hot-water supply systems.
- Transportation of highly viscous petroleum products.

## Schedule of diameters

From 1.26 to 20.87 in.—for pipes thermally insulated with FPU;  
6.26 to 20.87 in.—for pipes with combined insulation.

## Operating temperature

- 284 °F—operating temperature (for pipes thermally insulated with FPU).
- 302 °F—peak temperature (for pipes thermally insulated with FPU).
- 464 °F (for pipes with combined thermal insulation).
- 680 °F (for pipes with combined thermal insulation).

## Advantages

Pipelines in foam polyurethane thermal insulation allows to:

- reduce the heat loss 2-2.5 times compared to conventional materials;
- when using the Operational Remote Control System (ORCS), monitor damage to the pipeline thermal insulation;
- reduce the cost of capital construction 1.5 times as compared to trenched pipelines in conventional types of insulation;
- reduce the annual cost of heating network operation 9-10 times;
- operate the pipeline over the long term without repair.

## Reliability

- Ensured by the factory assembly, made in the shop environment.
- High-quality waterproofing, which is ensured by a protective shell and monitored over the entire service life of the ORCS.
- Ensured by the strength of the FPU in compression and bending in the limits of the standard value of GOST 30732-2006.

## Product Advantages

1. Minimal thermal conductivity.
2. Resistance to mechanical stress.
3. No reaction with chemically active medium.
4. High heat and energy saving performance.



Winner of the competition  
"100 Best Goods of  
Russia"



Contest diploma winner  
"100 Best Products of the  
Republic of Tatarstan"





# TYPES OF HEAT-INSULATED PIPES

## Steel pipes heat-insulated with polyurethane foam, equipped with ORCS (TU 24.20.13-118-78682242-2022)

Pipe, heat-insulated with polyurethane foam, in a polyethylene sheathing, with ORCS:

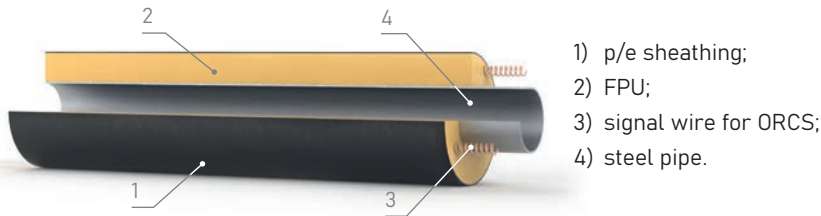

- 1) p/e sheathing;
- 2) FPU;
- 3) signal wire for ORCS;
- 4) steel pipe.

Pipe, heat-insulated with polyurethane foam, in a galvanized sheathing:

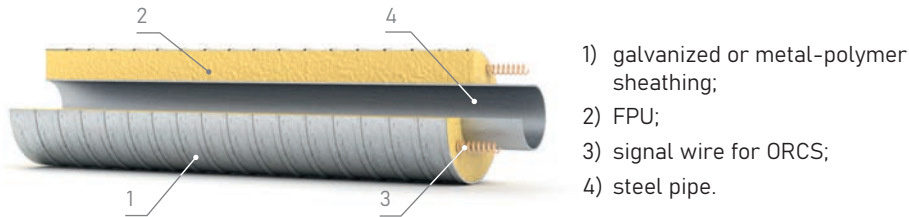

- 1) galvanized or metal-polymer sheathing;
- 2) FPU;
- 3) signal wire for ORCS;
- 4) steel pipe.

## Steel pipes with combined sheathing, equipped with the system "skin effect"



The "skin effect" system is intended for frost protection, start-up warm-up and temperature maintenance of the transported product. It is used in explosion-hazard zones and allows maintaining the temperature of the pipeline up to 18.64 mi long without an accompanying network.

## Pipes and pup-joints of steel, insulated with polyurethane foam, equipped with fire-prevention inserts

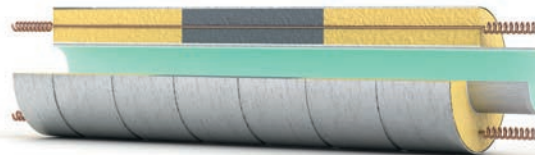

### Purpose

To ensure reliable fire safety of a heat-insulated pipe by eliminating the possibility of spreading fire over the entire length if ignition of its combustible heat-insulation occurs.



Winner of the competition "100 Best Goods of Russia"



Contest diploma winner "100 Best Products of the Republic of Tatarstan"

Name	Values
Schedule of diameters	1.26 to 20.87 in.
Operating temperature	up to +680 °F
Heat loss reduction	2.5÷3 times

1. At the request of the customer, it is combined with an internal corrosion-resistant coating and a sleeve to protect the heat-affected zone.
2. At the request of the customer, all products can be equipped with linear indicators—the system of Operational Remote Control System (ORCS) or the "skin effect" system.

# SHAPED PARTS OF PIPELINES WITH HEAT-INSULATION OF POLYURETHANE FOAM

(TU 24.20.13-118-78682242-2022, TU 22.21.41-130-78682242-2023, TU 24.20.13-126-78682242-2022)

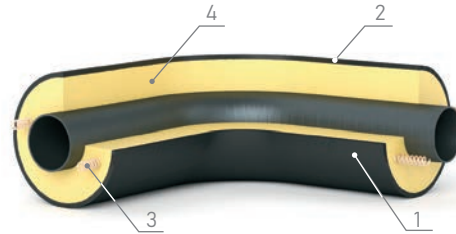

## Preinsulated part (branch) in p/e sheathing with ORCS

- 1) p/e sheathing;
- 2) FPU;
- 3) signal wire for ORCS;
- 4) steel pipe.



## Steel pipes and shaped products with combined heat insulation

are used in the construction of pipelines transporting high-temperature coolant with temperatures of up to 464-680 °F, depending on the thickness of the basalt insulation layer.

## Purpose

Insulated with polyurethane foam shaped parts of pipelines:

branches, tees, crossovers, movable and fixed supports, which are designed for construction of heat-insulation pipelines of underground trenchless laying and in galvanized sheathing for above-ground routing of pipelines.

## Product range

- branch in steel and polyethylene sheathing;
- S-shaped branches;
- pipe adapter in steel and polyethylene sheathing;
- tee;
- Z-shaped element;
- fixed support;
- pipeline element with the cable outlet;
- sliding support;
- shells for linear pipeline joints;
- shells for heat insulation of wellhead injection wells.

## Advantages

- Heat insulation, not only of pipes, but also all shaped products used in pipeline construction reduces the heat loss of the pipeline to a minimum.
- Production and delivery of pipes and shaped products from the same manufacturer, the same type of insulation.
- Excellent tolerance of frost and high temperatures without losing its original shape.

# TUBING, CASING, AND LINE PIPES OF STEEL WITH INTERNAL CORROSION-RESISTANT COATING TU 24.20.13-027-67740692-2018 (TU 1390-007-67740692-2017, TU 1320-002-67740692-2013, TU 24.20.13-116-78682242-2022, TU 24.20.13-117-78682242-2023, TU 24.20.12-123-78682242-2023)



## Purpose of coating

Protects the inside surface of tubing, casing, and couplings thereto as well as line pipes against corrosion.

## Field of application

Coated tubings are intended to be used in injection and production wells operating in flowing mode or equipped with electric centrifugal pumps, as well as in wells of the FPM system (formation pressure maintenance system).

Coated casing pipes—for lining oil and gas wells with an extended service life.

Coated line pipes—for construction, revamping, and repair of industrial and process oil and gas pipelines, water pipelines.



## Types of internal coating depending on operating conditions:

- standard 176;
- thermo 248;
- thermo 302 and more (maximum t 176, 248, 302 °F).

## Range of coated pipes

- Tubing from 2.36 to 4.49 in.;
- Casing from 4.49 to 13.39 in.;
- Linear from 2.36 to 20.87 in.

## Coating design

- single-layer based on highly viscous materials;
- two-layer powder-based materials.



## Coating properties

- resistant to oil, fuels, industrial and waste water;
- resistant to the damaging effects of stray currents.
- high degree of coatings adherence to the steel surface (adhesion).
- high mechanical strength.

## Advantages

- Products are certified for compliance with GOST R.
- The management system is certified to compliance with GOST R ISO 9001-2015.
- 100% incoming inspection of steel products is ensured, including the inspection of steel pipe and coating materials.
- Qualified specialists at all stages of manufacturing and inspection.
- Availability of in-house certified and accredited unified quality laboratory.
- Selection of coating materials, pipe steel grades depending on the pipeline operating conditions.

## Technical features

Property values	Regulatory data
Coating color	as per the material reference documentation
Thickness, in., not less	0.014
Dielectric continuity of the coating	no breakdown at 5 V voltage per coating thickness
Adhesion of coating to steel by X-notch method, point, NOV	1
Adhesion of coating to steel by pull-off method, ksi, not less	1.45

# SLEEVE TPS-TK

## SPEC. TU 24.20.13-138-78682242-2022



### Purpose

Prevention of all types of corrosion on inner surfaces of weld and weld-adjacent zones of steel pipelines.

### Application

Low-pressure water pipelines of reservoir pressure maintenance systems, oil-gathering systems, field and process oil pipelines transporting corrosive fluids.

### Advantages

- Saves 95% of the internal pipeline cross-section.
- Installed 1.5 times faster than commonly used bushings.
- Ensures tight joint and secure fixation over the entire operating lifetime.
- No risk of failure in the field (therefore, no need to use sealing compounds).
- Does not require any imported components.
- Reduces back pressure and prevents cavitation while in use, thereby lowering energy consumption and accident rate of pipelines.



### Specifications

Operating pressure, psi	587.8
Diameter, in	3.5-12.8
Length, in	6.3-7.87
Max operating temperature, °F	257

### Manufacturer's Warranty

The manufacturer guarantees that bushings conform to the specifications providing that the condition requirements for transportation, storage, handling, installation, and operation are met.

The operating lifetime of bushings is 20 years from the date of installation in the pipeline weld zone.

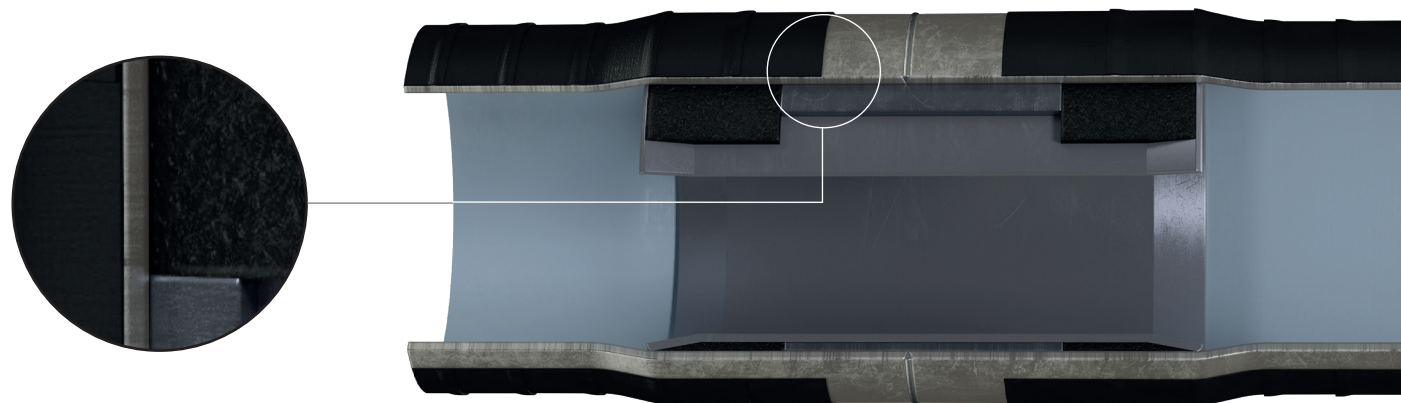



# POLYETHYLENE PIPES



TU 2248-015-67740692-2010, TU 21.21.21-120-78682242-2022 FOR INDUSTRIAL APPLICATIONS  
TU 2248-014-67740692-2010, TU 22.21.21-132-78682242-2022 FOR SERVICE AND DRINKING WATER  
SUPPLY TU 2248-017-67740692-2010, TU 22.21.21-134-78682242-2023 FOR GAS PIPELINES



## Purpose

- For the construction of free-flow conduits for industrial application.
- For heat insulation of pipes as outer protective sheathing.
- For cable routing.
- For the construction of pressure pipelines for service and drinking water supply.
- For construction of underground gas pipelines at maximum gas temperature up to 104 °F and operating pressure up to 0.17 ksi.

## Diameter range

- Industrial, Ø from 2.6 to 21.26 in.
- Drinking, as per GOST 18599.
- Gas, as per GOST R 50838.

Supplied in straight sections, bundles.

## Materials used

- PE 80.
- PE 100.

## Advantages

- Absence of all types of corrosion.
- Low microbiological fouling.
- Polyethylene water-service pipes are environmentally friendly, toxicologically and bacteriologically safe.
- Good heat-insulating properties.
- No effect on the gustatory qualities and odor of drinking water.
- High durability (guaranteed service life of 50 years).
- Over time, the polyethylene pipe capacity does not deteriorate (there is no mechanical clogging of the water service pipe due to the low surface roughness).
- High resistance of polyethylene pipes to mechanical overloads due to such properties of polyethylene as elasticity.
- Polyethylene pipes are 2-4 times lighter than steel, which greatly facilitates their transportation and installation.
- The butt welding of polyethylene pipes is much cheaper, more reliable and easier, takes less time and does not require consumables (insulation, electrodes).

# EXTERNAL CORROSION-RESISTANT COATING OF STEEL PIPES BASED ON POWDER MATERIALS (TU 1390-018-67740692-2017, TU 24.20.13-135-78682242-2023)



## Purpose

Corrosion-resistant polymer coating based on powder materials is intended to protect steel pipelines for various purposes against the corrosive effect of the environment.

## Field of application

Powder-coated pipes are designed for:

- underground laying and in places where there is no possibility of using the external polyethylene insulation due to the high operating temperature of the pipeline (above +176 °F);
- for above-ground routing;
- as the corrosion-resistant coating in combination with heat insulation.

## Advantages

- The coating is resistant to ultraviolet and heat aging and does not crack during its entire service life.
- High resistance to atmospheric and soil corrosion, as well as to cathodic disbonding and prolonged exposure to water.
- A wide range of color coating.
- Can be used as part of more complex, combined heat-insulating and corrosion-resistant coatings or as an anti-corrosion coating in combination with heat insulation.
- Can be used with an internal polymer powder coating.
- The coating does not shield the cathodic protection currents.

The service life of steel pipes externally coated with powder-based materials is more than 20 years

## Technical features

Name	Values
Pipeline diameter, in.	4.25 to 32.28
Operating temperature, °F	-76... +302
Coating thickness, in.	at least 0.014
Adhesion strength index by pull-off method, ksi	over 18
Depth of coating penetration at a load of 110.2 lb, in.	0.0067

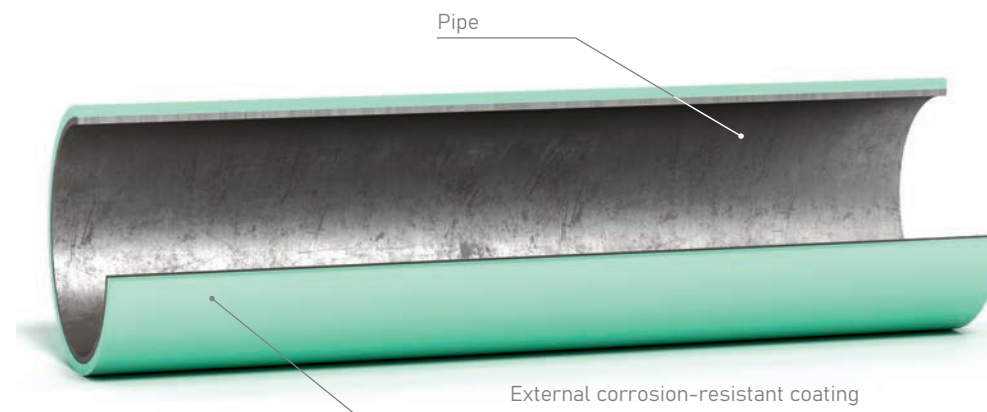

# MEST™ MECHANICAL ELECTRICALLY INSULATING CONNECTION OF PIPELINES



Mechanical electric insulating connection of pipelines (MEST™) is designed for electrical separation of pipelines from other underground structures. Electrical isolation is carried out for the purpose of elimination or limiting stray currents in the pipeline, induced by DC or AC earthing devices in high-voltage power lines, as well as to eliminating the dissipation of protective currents of electrochemical (mainly protector) protection.

## Manufacturing options

1. MEST for MPT pipelines (MPTK) (metal-plastic pipes / metal-plastic corrosion resistant pipes).
2. MEST for pipelines of other designs (pipes with external polymer coating, with internal polymer coating, steel pipes).

## Introducing connections ensures

- No impact of induced currents in the common pipeline on the operation of accurate and expensive metering devices.
- Elimination of discharges over the course of operation of pipelines in explosion-hazardous premises.
- Elimination of dissipation of protective currents of electrochemical protection of equipment.

## Advantages

- Installation is simple and does not require special devices.
- Operational reliability due to simple design.
- Short payback period by reducing the cost of repair or replacement of expensive metering equipment.
- No maintenance required.
- Can be installed anywhere in the pipeline.
- Service life of at least 15 years.

## End preparation options

1. Under welded joint.
2. For welded joint with corrosion-resistant steel tips.

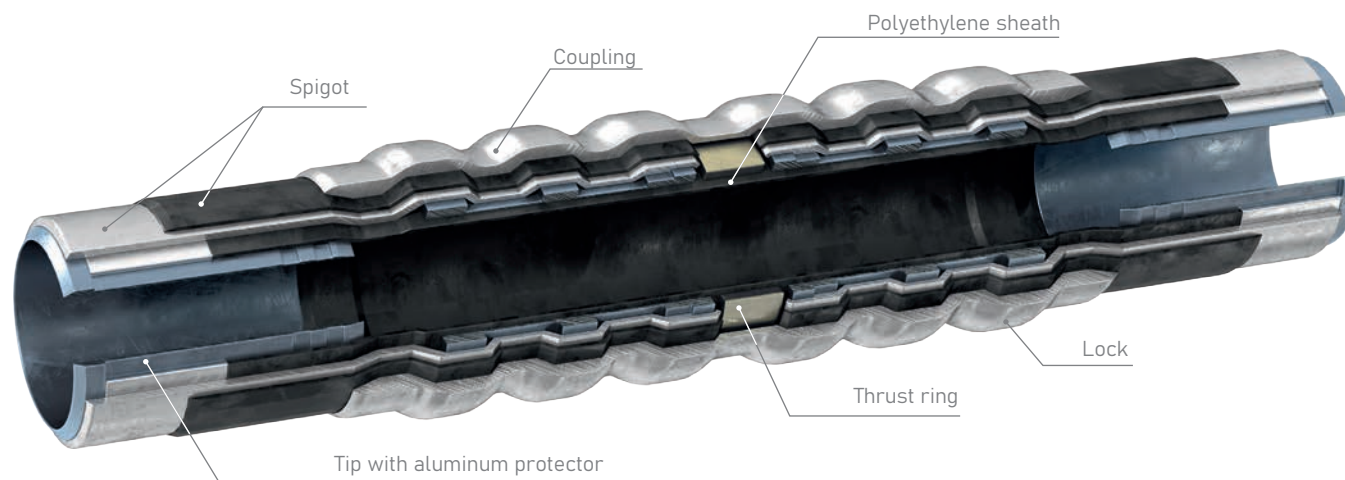

1) High-pressure MEST design up to 3.05 ksi

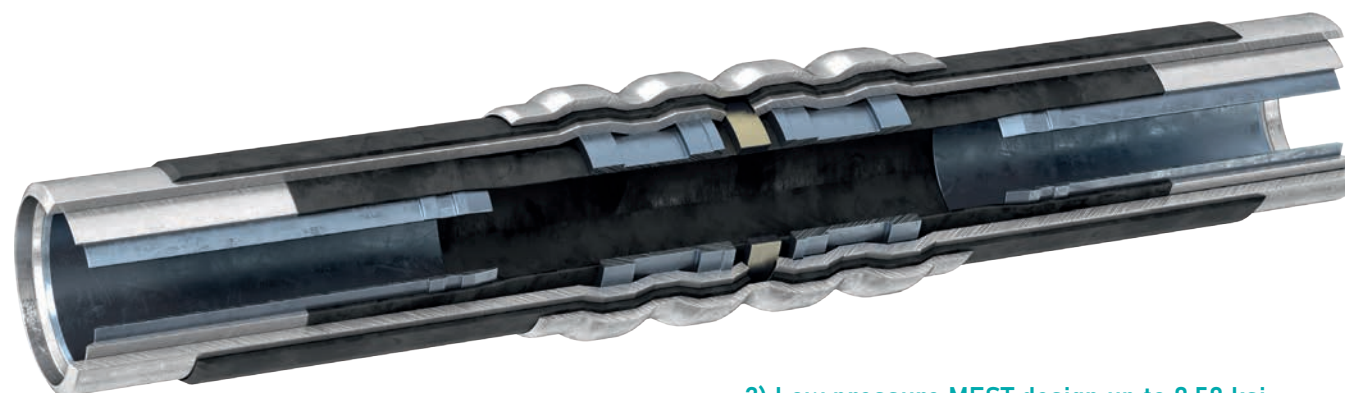

2) Low pressure MEST design up to 0.58 ksi

### Technical features

Parameters determining the mechanical strength of MEST in the axial direction	Pipe size (diameter x wall thickness), in.							
	3.50×0.16	3.50×0.28	4.49×0.35	4.49×0.18	6.26×0.24	6.26×0.35	8.62×0.32	10.75×0.35
Maximum working pressure of the pipeline, P, ksi	0.58	3.05	3.05	0.58	0.58	3.05	0.58	0.58
Electrical resistance at U = 1000 V	at least 10 kOhm							



## Purpose

For use as packaging material in various sectors of national economy and for other technical needs, such as agriculture, land-improvement and water engineering.

## Issued brands:

- M — for the manufacture of shipping bags and other products that require the use of films of highest strength, stabilized and unstabilized, dyed and undyed.
- T — for the production of articles of industrial-use, construction of temporary structures, sheltering, packaging and combined films; stabilized and unstabilized, dyed and undyed.
- ST — for use in agriculture as a translucent weatherproof covering of indoor structures (greenhouses, hotbeds, etc.) and other purposes.
- SIK — for use in agriculture as a translucent weatherproof covering of greenhouses and other types of indoor structures, ensuring enhanced greenhouse effect, undyed, stabilized with IR-adsorbent.

SK — for use in agriculture in the preservation of fodder and other purposes; dyed and undyed, unstabilized.

SM — for use in agriculture as material for mulching and other purposes; undyed, soot-stabilized.

V, V1 — for use in land-improvement and water engineering as impervious screens;

V — undyed, comprehensively stabilized (including by soot), high-molecular; B1—undyed, stabilized soot.

## Operating conditions

The film operating temperature is from -49 to +122 °F. The film color is determined by the purpose and the desire of the customer.

## Technical features

Thickness, in , for grade					Limit deviation, %, from nominal thickness
M, T	ST, SK	SM	SIK	V, V1	
0.0039	0.0039	0.0039	0.0039	-	20
0.0047	0.0047	0.0047	0.0047	-	
0.0059	0.0059	0.0059	0.0059	-	
0.0079	0.0079	0.0079	0.0071	-	
0.0087	0.0087	0.0087	0.0079	0.0079	
0.0098	0.0098	-	0.0087	0.0098	
0.0118	0.0118	-	0.0098	0.0118	



A large, stylized graphic on the left side of the page, resembling a capital letter 'E'. It is composed of a light purple circular shape on the left and a dark purple curved shape on the right, with two horizontal white bars connecting them in the center.

# OTHER SERVICES

## OTHER SERVICES

105 | SCRAP METAL TRADING

106 | RENDERING OF METROLOGICAL  
SERVICES

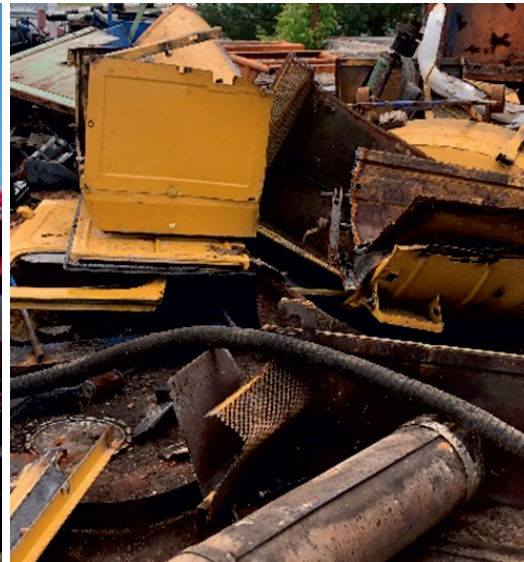

## Services rendered

- Scrap collection
- Storing
- Recycling
- Selling

## Main categories of scrap metal reception

- 3A
- 5A
- 12A
- 13A
- 26A

## Advantages

- Acceptance of scrap and ferrous waste at high prices.
- Flexible payment system.
- Scrap metal removal by own forces.

Equipped with all the necessary equipment; in-house base



## Scope of competence recognition in terms of calibration work

- Calibration of devices for measuring of geometric quantities.
- Control of geometric parameters of threaded parts of tubing and casing, couplings for tubing and casing pipes.
- Other geometric measurements.

## Advantages

- Short turnaround time.
- Competitive price.
- Flexible payment system.







TMC Group Managing Company LLC  
1A Obyezdnoy trakt,  
Almetyevsk



[tms.tagras.ru/en](https://tms.tagras.ru/en)

+7 (8553) 300-442  
fax: 371-381  
[tmcg@tmcg.ru](mailto:tmcg@tmcg.ru)